



TEMAHOME

RETAIL

Price list
January 2023

Made in Portugal





INDEX	pages
MODULAR SYSTEMS	
JOIN	1 - 4
POMBAL	4 - 5
SHELVING UNITS	
ALBI	6 - 6
BERLIN	6 - 7
DELTA	7 - 8
DUBLIN	8 - 9
ELLA	9 - 9
GROUP	9 - 9
LONDON	10 - 10
ONE	11 - 11
STEP	11 - 11
VALSA	11 - 12
WIND	12 - 12
WALL MOUNTED PRODUCTS	
BALDA	13 - 13
BERN	13 - 13
PLY	13 - 13
COFFEE AND SIDE TABLES	
ALBI	14 - 14
BERLIN	14 - 14
BRUNO	14 - 14
DETROIT	15 - 15
GLEAM	15 - 18
HELIX	18 - 18
KLAUS	18 - 18
NINA	18 - 18
NORA	19 - 19
OVAL	19 - 19
PETRA	19 - 19
PLY	20 - 20
PRAIRIE	20 - 20
RADIO	21 - 21
SLATE	21 - 21
SONATA	21 - 21

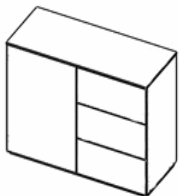
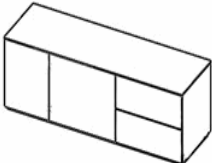
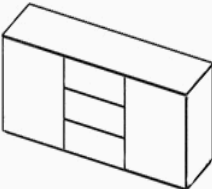
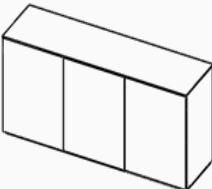
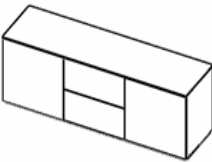
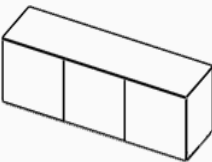
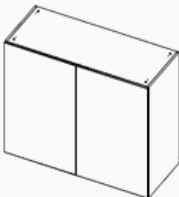



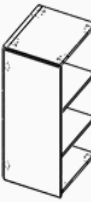
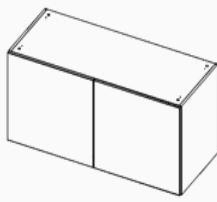
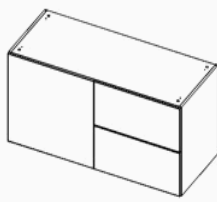

INDEX	pages
TV STANDS	
ALBI BERLIN CLIFF DETROIT DIXIE MOVE NARA NINA RADIO	22 - 22 22 - 22 22 - 22 22 - 22 22 - 22 23 - 23 23 - 23 23 - 23 23 - 23
DINING TABLES	
APEX DETROIT DRIFT DUSK LAGO	24 - 24 24 - 24 24 - 24 25 - 25 26 - 26
BAR TABLES	
ROLL	27 - 27
SIDEBOARDS	
ALBI DANN EDGE KOBE NINA RADIO VINY	28 - 28 28 - 28 28 - 28 29 - 29 29 - 29 29 - 29 29 - 29
CUPBOARD	
NINA	30 - 30





INDEX	pages
HOME OFFICE	
AURA	31 - 31
BRISTOL	31 - 31
CITY	31 - 31
DETROIT	31 - 31
FIORE	31 - 31
FLOW	32 - 32
FOCUS	32 - 32
HARBOUR	32 - 32
LIME	32 - 32
LOFT	32 - 32
MAYA	33 - 33
MITCH	33 - 33
MULTI	33 - 34
PLY	34 - 34
PRADO	34 - 34
SPACE	35 - 35
VOLGA	35 - 35
CONSOLES	
BERLIN	36 - 36
GLEAM	36 - 37
HELIX	37 - 37
SEATING	
DETROIT	38 - 38
SALLY	38 - 38
BEDROOMS	
AURORA	39 - 39
FLOAT	39 - 41
HUGO	41 - 41
CHEST OF DRAWERS	
HUGO	42 - 42
VANITY TABLES	
HUGO	43 - 43



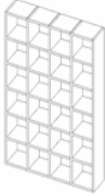
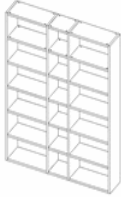

JOIN		finishes	product code	package code	pack. m3 kg	PLN
JOIN 120H2 - BASE		H 84 cm W 120 cm D 50 cm Kg 74 m3 0,25 pack.qty. 4	WHITE	9500.404269		3640
			WHITE / OAK	9500.404276		3640
			WHITE / WALNUT	9500.404283		3640
JOIN 160L2 - BASE		H 57 cm W 160 cm D 50 cm Kg 77 m3 0,25 pack.qty. 5	WHITE	9500.404627		3680
			WHITE / OAK	9500.404634		3680
			WHITE / WALNUT	9500.404641		3680
JOIN 180H1 - BASE		H 84 cm W 180 cm D 50 cm Kg 108 m3 0,36 pack.qty. 5	WHITE	9500.404382		4790
			WHITE / OAK	9500.404399		4790
			WHITE / WALNUT	9500.404405		4790
JOIN 180H2 - BASE		H 84 cm W 180 cm D 50 cm Kg 104 m3 0,34 pack.qty. 5	WHITE	9500.405129		3940
			WHITE / OAK	9500.405136		3940
			WHITE / WALNUT	9500.405143		3940
JOIN 180L1 - BASE		H 57 cm W 180 cm D 50 cm Kg 83 m3 0,27 pack.qty. 5	WHITE	9500.405266		3830
			WHITE / OAK	9500.405228		3830
			WHITE / WALNUT	9500.405235		3830
JOIN 180L2 - BASE		H 57 cm W 180 cm D 50 cm Kg 80 m3 0,26 pack.qty. 5	WHITE	9500.405365		3300
			WHITE / OAK	9500.405327		3300
			WHITE / WALNUT	9500.405334		3300
KIT A 120 HIGH JOIN 2DOORS		H 80 cm W 120 cm D 49 cm Kg 58 m3 0,15 pack.qty. 2	WHITE	9500.403231		2020

MODULAR SYSTEMS

JOIN		finishes	product code	package code	pack. m3	kg	PLN
KIT A 120 HIGH JOIN 1DOOR + 3DRAWERS		H 80 cm W 120 cm D 49 cm Kg 62 m3 0,18 pack.qty. 2	WHITE	9500.403248			2870
KIT A 120 HIGH JOIN 6 DRAWERS		H 80 cm W 120 cm D 49 cm Kg 66 m3 0,20 pack.qty. 3	WHITE	9500.403361			3720
KIT B 60 HIGH JOIN 1DOOR		H 80 cm W 60 cm D 49 cm Kg 27 m3 0,08 pack.qty. 1	WHITE	9000.403118		0,08 28	990
KIT B 40 HIGH JOIN 1DOOR		H 80 cm W 41 cm D 49 cm Kg 20 m3 0,05 pack.qty. 1	WHITE	9000.403309		0,05 20	850
KIT A 120 LOW JOIN 2DOORS		H 53 cm W 120 cm D 49 cm Kg 42 m3 0,10 pack.qty. 2	WHITE	9500.403378			1600
KIT A 120 LOW JOIN 1DOOR+2DRAWERS		H 53 cm W 120 cm D 49 cm Kg 45 m3 0,12 pack.qty. 2	WHITE	9500.403255			2130
KIT A 120 LOW JOIN 4 DRAWERS		H 53 cm W 120 cm D 49 cm Kg 48 m3 0,12 pack.qty. 2	WHITE	9500.403385			2640

JOIN		finishes	product code	package code	pack. qty	m3	kg	PLN
KIT B 60 LOW JOIN 1DOOR		H 53 cm W 60 cm D 49 cm Kg 19 m3 0,05 pack.qty. 1	WHITE	9000.403125		0,05	20	770
KIT B 40 LOW JOIN 1DOOR		H 53 cm W 41 cm D 49 cm Kg 14 m3 0,04 pack.qty. 1	WHITE	9000.403316		0,04	15	660
TOP 120 JOIN		H 1 cm W 120 cm D 50 cm Kg 7 m3 0,03 pack.qty. 1	WHITE	9000.403767		0,03	7	400
			OAK	9003.403668		0,03	8	400
			WALNUT	9003.403712		0,03	8	400
TOP 160 JOIN		H 1 cm W 160 cm D 50 cm Kg 9 m3 0,04 pack.qty. 1	WHITE	9000.403774		0,04	9	460
			OAK	9003.403675		0,04	10	460
			WALNUT	9003.403729		0,04	10	460
TOP 180 JOIN		H 1 cm W 180 cm D 50 cm Kg 10 m3 0,05 pack.qty. 1	WHITE	9000.403781		0,05	10	490
			OAK	9003.403682		0,05	11	490
			WALNUT	9003.403736		0,05	11	490
BASE 120 JOIN		H 3 cm W 118 cm D 45 cm Kg 5 m3 0,04 pack.qty. 1	WHITE	9000.403965		0,04	6	370
BASE 160 JOIN		H 3 cm W 158 cm D 45 cm Kg 7 m3 0,05 pack.qty. 1	WHITE	9000.403972		0,05	7	430



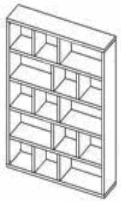
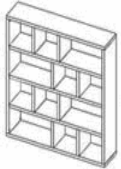

MODULAR SYSTEMS									
JOIN			finishes	product code	package code	pack. qty	m3	kg	PLN
BASE 180 JOIN		H 3 cm W 178 cm D 45 cm Kg 8 m3 0,05 pack.qty. 1	WHITE	9000.403989			0,05	8	440
POMBAL			finishes	product code	package code	pack. qty	m3	kg	PLN
COMP. POMBAL 2010-001		H 224 cm W 151 cm D 34 cm Kg 80 m3 0,37 pack.qty. 4	WALNUT	9500.510403	9003.948312	1	0,11	26	5850
					9003.948329	3	0,09	18	
			OAK	9500.515897	9003.319105	1	0,11	26	5850
					9003.319112	3	0,09	18	
COMP. POMBAL 2010-018		H 224 cm W 181 cm D 34 cm Kg 80 m3 0,33 pack.qty. 3	WALNUT	9500.515262	9003.948336	1	0,14	35	5770
					9003.948329	1	0,09	18	
					9003.948343	1	0,11	28	
			OAK	9500.515941	9003.319129	1	0,14	35	5770
COMP. POMBAL 2012-055		H 224 cm W 255 cm D 34 cm Kg 117 m3 0,51 pack.qty. 5	WALNUT	9500.317811	9003.948312	1	0,11	26	8470
					9003.948329	2	0,09	18	
					9003.948343	2	0,11	28	
			OAK	9500.515934	9003.319105	1	0,11	26	8470
KIT A 224 x 40 CM		H 224 cm W 40 cm D 34 cm Kg 25 m3 0,11 pack.qty. 1			9003.319112	2	0,09	18	
					9003.319136	2	0,11	28	
			WHITE	9500.317835	9000.310607	1	0,11	24	8470
					9000.310614	2	0,09	18	
KIT A 224 x 40 CM		H 224 cm W 40 cm D 34 cm Kg 25 m3 0,11 pack.qty. 1			9000.310638	2	0,11	27	
			CONCRETE MELAMINE	9500.516290	9000.319648	1	0,11	24	6790
					9000.319655	2	0,09	17	
					9000.319464	2	0,11	26	
KIT A 224 x 40 CM		H 224 cm W 40 cm D 34 cm Kg 25 m3 0,11 pack.qty. 1	WALNUT	9003.948312			0,11	26	1890
			OAK	9003.319105			0,11	26	1890
			WHITE	9000.310607			0,11	24	1890
			CONCRETE MELAMINE	9000.319648			0,11	24	1510

POMBAL		finishes	product code	package code	pack. qty	m3	kg	PLN
KIT B 224 x 37 CM		H 224 cm	WALNUT	9003.948329		0,09	18	1320
		W 37 cm	OAK	9003.319112		0,09	18	1320
		D 34 cm	WHITE	9000.310614		0,09	18	1320
		Kg 18	CONCRETE	9000.319655		0,09	17	1060
m3 0,09	MELAMINE							
pack.qty. 1								
KIT A 224 x 74 CM		H 224 cm	WALNUT	9003.948336		0,14	35	2480
		W 74 cm	OAK	9003.319129		0,14	35	2480
		D 34 cm	WHITE	9000.310621		0,14	33	2480
		Kg 34	CONCRETE	9000.319457		0,14	33	2000
m3 0,14	MELAMINE							
pack.qty. 1								
KIT B 224 x 71 CM		H 224 cm	WALNUT	9003.948343		0,11	28	1970
		W 71 cm	OAK	9003.319136		0,11	28	1970
		D 34 cm	WHITE	9000.310638		0,11	27	1970
		Kg 31	CONCRETE	9000.319464		0,11	26	1580
m3 0,11	MELAMINE							
pack.qty. 1								
DRAWER UNIT (68 CM)		H 34 cm	WHITE	9000.311390		0,09	19	1420
W 68 cm								
D 34 cm								
Kg 19								
m3 0,09								
pack.qty. 1								
BERLIN BOX		H 34 cm	WHITE	9000.320651		0,02	5	400
		W 34 cm	GREY	9000.317002		0,02	5	400
		D 33 cm	BLACK	9000.316678		0,02	5	400
		Kg 4	RED	9000.316685		0,02	5	400
m3 0,02								
pack.qty. 1								

SHELVING UNITS

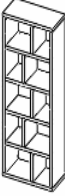
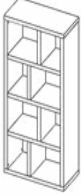
ALBI		finishes	product code	package code	pack. qty	m3	kg	PLN	
ALBI BOOKCASE		H 197 cm W 120 cm D 38 cm Kg 49 m3 0,17 pack.qty. 2	LIGHT OAK / WHITE	9500.322334	9003.322341	1	0,06	31	3670
			METAL		9000.322358	1	0,11	18	
		WALNUT / BLACK	9500.322426	9003.322433	1	0,06	31	3670	
		METAL		9000.322440	1	0,11	18		
BERLIN		finishes	product code	package code	pack. qty	m3	kg	PLN	
BERLIN 5 LEVELS 150		H 198 cm W 150 cm D 34 cm Kg 80 m3 0,38 pack.qty. 3	WALNUT	9500.318634	9003.318603	1	0,13	30	3520
					9003.318634	1	0,16	29	
					9003.318627	1	0,09	21	
			OAK	9500.316777	9003.316739	1	0,13	30	3520
					9003.316777	1	0,16	30	
					9003.316753	1	0,09	22	
		CONCRETE MELAMINE	9500.320309	9000.320316	1	0,13	30	2940	
				9000.320323	1	0,16	30		
				9000.320330	1	0,09	22		
		WHITE / PLYWOOD	9500.318115	9000.318146	1	0,13	28	2810	
				9000.318115	1	0,16	28		
				9000.318139	1	0,09	20		
WHITE	9500.320729	9000.320668	1	0,13	28	2810			
		9000.320675	1	0,16	28				
		9000.320682	1	0,09	20				
BERLIN 4 LEVELS 150		H 159 cm W 150 cm D 34 cm Kg 65 m3 0,28 pack.qty. 3	WALNUT	9500.318603	9003.318603	1	0,13	30	2920
					9003.318610	1	0,05	15	
					9003.318627	1	0,09	21	
			OAK	9500.316739	9003.316739	1	0,13	30	2920
					9003.316746	1	0,05	15	
					9003.316753	1	0,09	22	
		CONCRETE MELAMINE	9500.322518	9000.320316	1	0,13	30	2440	
				9000.322488	1	0,05	15		
				9000.320330	1	0,09	22		
		WHITE / PLYWOOD	9500.318122	9000.318146	1	0,13	28	2340	
				9000.318122	1	0,05	14		
				9000.318139	1	0,09	20		
WHITE	9500.320736	9000.320668	1	0,13	28	2340			
		9000.320699	1	0,07	14				
		9000.320682	1	0,09	20				

SHELVING UNITS

BERLIN			finishes	product code	package code	pack. qty	m3	kg	PLN
BERLIN 5 LEVELS 70		H 198 cm W 70 cm D 34 cm Kg 47 m3 0,18 pack.qty. 2	WALNUT	9500.320200	9003.318641	1	0,08	24	2330
					9003.320200	1	0,10	23	
			OAK	9500.320187	9003.316791	1	0,08	25	2330
					9003.320187	1	0,10	24	
			CONCRETE MELAMINE	9500.322525	9000.322495	1	0,08	25	1980
					9000.322501	1	0,10	24	
			WHITE / PLYWOOD	9500.320217	9000.318108	1	0,08	23	1870
		9000.320217	1	0,10	22				
			WHITE	9500.320750	9000.320705	1	0,09	23	1870
					9000.320712	1	0,11	22	
BERLIN 4 LEVELS 70		H 159 cm W 70 cm D 34 cm Kg 39 m3 0,14 pack.qty. 2	WALNUT	9500.318641	9003.318641	1	0,08	24	1960
					9003.318610	1	0,05	15	
			OAK	9500.316791	9003.316791	1	0,08	25	1960
					9003.316746	1	0,05	15	
			CONCRETE MELAMINE	9500.322532	9000.322495	1	0,08	25	1630
					9000.322488	1	0,05	15	
			WHITE / PLYWOOD	9500.318108	9000.318108	1	0,08	23	1570
		9000.318122	1	0,05	14				
			WHITE	9500.320743	9000.320705	1	0,09	23	1570
					9000.320699	1	0,07	14	
BERLIN BOX		H 34 cm W 34 cm D 33 cm Kg 4 m3 0,02 pack.qty. 1	WHITE	9000.320651			0,02	5	400
			GREY	9000.317002			0,02	5	400
			BLACK	9000.316678			0,02	5	400
			RED	9000.316685			0,02	5	400
DELTA			finishes	product code	package code	pack. qty	m3	kg	PLN
DELTA 001		H 195 cm W 76 cm D 30 cm Kg 27 m3 0,09 pack.qty. 2	WHITE	9500.315305	9000.315305	1	0,05	19	1270
					9000.315343	1	0,03	9	
			BLACK	9500.315367	9000.315367	1	0,05	19	1270
					9000.315411	1	0,03	9	
			GREY	9500.316357	9000.316326	1	0,05	19	1270
					9000.317644	1	0,03	9	
DELTA 002		H 195 cm W 97 cm D 30 cm Kg 45 m3 0,14 pack.qty. 3	WHITE	9500.315350	9000.315305	1	0,05	19	2240
					9000.315336	1	0,06	20	
					9000.315350	1	0,03	8	
			BLACK	9500.315398	9000.315367	1	0,05	19	2240
					9000.315398	1	0,06	20	
					9000.315404	1	0,03	8	
						GREY	9500.316340	9000.316326	1
					9000.316357	1	0,06	20	
					9000.316371	1	0,03	8	

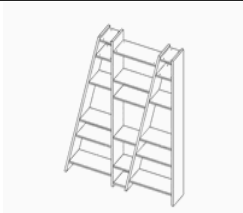
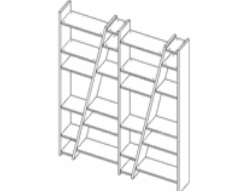
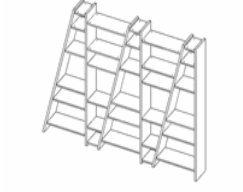
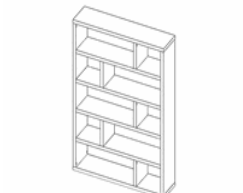

SHELVING UNITS

DELTA		finishes	product code	package code	pack. qty	m3	kg	PLN
DELTA 003		WHITE	9500.315312	9000.315305	1	0,05	19	3230
				9000.315336	1	0,06	20	
				9000.315329	1	0,05	19	
				9000.315343	1	0,03	9	
		BLACK	9500.315381	9000.315367	1	0,05	19	3230
				9000.315398	1	0,06	20	
				9000.315381	1	0,05	19	
				9000.315411	1	0,03	9	
		GREY	9500.316371	9000.316326	1	0,05	19	3230
				9000.316357	1	0,06	20	
				9000.316364	1	0,05	19	
				9000.317644	1	0,03	9	
DELTA 004		WHITE	9500.315336	9000.315305	1	0,05	19	4200
				9000.315336	2	0,06	20	
				9000.315329	1	0,05	19	
				9000.315350	1	0,03	8	
		BLACK	9500.315404	9000.315367	1	0,05	19	4200
				9000.315398	2	0,06	20	
				9000.315381	1	0,05	19	
				9000.315404	1	0,03	8	
		GREY	9500.316326	9000.316326	1	0,05	19	4200
				9000.316357	2	0,06	20	
				9000.316364	1	0,05	19	
				9000.316371	1	0,03	8	
DELTA 005		WHITE	9500.315343	9000.315305	1	0,05	19	5190
				9000.315336	2	0,06	20	
				9000.315329	2	0,05	19	
				9000.315343	1	0,03	9	
		BLACK	9500.315411	9000.315367	1	0,05	19	5190
				9000.315398	2	0,06	20	
				9000.315381	2	0,05	19	
				9000.315411	1	0,03	9	
		GREY	9500.316418	9000.316326	1	0,05	19	5190
				9000.316357	2	0,06	20	
				9000.316364	2	0,05	19	
				9000.317644	1	0,03	9	
DUBLIN		finishes	product code	package code	pack. qty	m3	kg	PLN
DUBLIN HIGH		MUKALI	9003.315985			0,17	40	1990
		WHITE	9000.317569			0,19	40	1990
		CONCRETE MELAMINE	9000.322594			0,19	37	1990

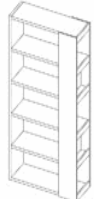
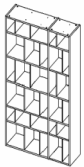
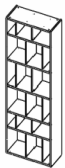
SHELVING UNITS

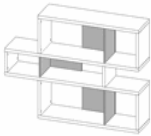
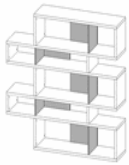

DUBLIN			finishes	product code	package code	pack. qty	m3	kg	PLN
DUBLIN LOW		H 105 cm W 120 cm D 29 cm Kg 26 m3 0,11 pack.qty. 1	MUKALI	9003.315992			0,11	26	1330
			WHITE	9000.319860			0,12	27	1330
			CONCRETE MELAMINE	9000.322600			0,11	24	1330
ELLA			finishes	product code	package code	pack. qty	m3	kg	PLN
ELLA		H 188 cm W 90 cm D 34 cm Kg 47 m3 0,13 pack.qty. 2	LIGHT OAK	9500.323539	9000.323546	1	0,05	21	2050
			MELAMINE / WHITE		9000.323553	1	0,07	26	
GROUP			finishes	product code	package code	pack. qty	m3	kg	PLN
GROUP 108		H 188 cm W 108 cm D 32 cm Kg 79 m3 0,16 pack.qty. 3	WHITE / PLYWOOD	9500.322907	9000.322884	1	0,07	32	2750
					9000.322891	1	0,04	21	
					9000.322914	1	0,05	27	
GROUP 72		H 188 cm W 72 cm D 32 cm Kg 52 m3 0,11 pack.qty. 2	WHITE / PLYWOOD	9500.322877	9000.322884	1	0,07	32	1780
					9000.322891	1	0,04	21	

SHELVING UNITS



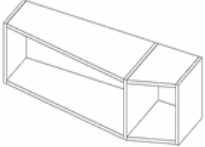
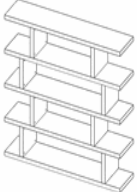
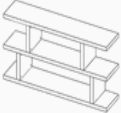
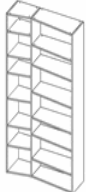
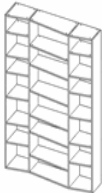
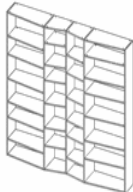

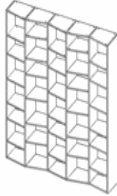
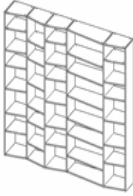
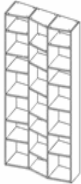
LONDON		finishes	product code	package code	pack. qty	m3	kg	PLN
LONDON 001		H 100 cm W 156 cm D 34 cm Kg 34 m3 0,12 pack.qty. 2	WHITE	9500.314803				2240
			WHITE / OAK	9500.319662				2240
			WHITE / WALNUT	9500.314810				2240
			WHITE / BLACK	9500.314827				2240
			OAK / WHITE	9500.319648				2800
			OAK	9500.319631				2800
			OAK / BLACK	9500.319655				2800
			WALNUT / WHITE	9500.314834				2800
			WALNUT	9500.314865				2800
WALNUT / BLACK	9500.314872				2800			
LONDON 002		H 160 cm W 156 cm D 34 cm Kg 55 m3 0,19 pack.qty. 4	WHITE	9500.314902				3650
			WHITE / OAK	9500.319709				3650
			WHITE / WALNUT	9500.314919				3650
			WHITE / BLACK	9500.314926				3650
			OAK / WHITE	9500.319686				4550
			OAK	9500.319679				4550
			OAK / BLACK	9500.319693				4550
			WALNUT / WHITE	9500.314933				4550
			WALNUT	9500.314940				4550
WALNUT / BLACK	9500.314957				4550			
LONDON 003		H 220 cm W 156 cm D 34 cm Kg 77 m3 0,26 pack.qty. 6	WHITE	9500.314964				5060
			WHITE / OAK	9500.319747				5060
			WHITE / WALNUT	9500.314971				5060
			WHITE / BLACK	9500.314988				5060
			OAK / WHITE	9500.319723				6300
			OAK	9500.319716				6300
			OAK / BLACK	9500.319730				6300
			WALNUT / WHITE	9500.314995				6300
			WALNUT	9500.314780				6300
WALNUT / BLACK	9500.314797				6300			

SHELVING UNITS

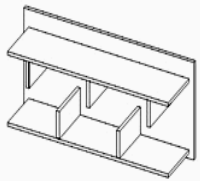

ONE			finishes	product code	package code	pack. qty	m3	kg	PLN
ONE		H 35 cm W 120 cm D 25/40 cm Kg 14 m3 0,04 pack.qty. 1	OAK / BLACK	9003.314858			0,04	14	800
			OAK / WHITE	9003.314896			0,04	14	800
STEP			finishes	product code	package code	pack. qty	m3	kg	PLN
STEP HIGH		H 172 cm W 163 cm D 36 cm Kg 72 m3 0,24 pack.qty. 2	WHITE	9500.273261	9000.273254	1	0,14	41	2730
					9000.273261	1	0,10	32	
			CONCRETE	9500.273278	9000.320224	1	0,14	37	3120
			MELAMINE / BLACK		9000.273278	1	0,11	28	
STEP LOW		H 88 cm W 163 cm D 36 cm Kg 41 m3 0,14 pack.qty. 1	WHITE	9000.273254			0,14	41	1520
			CONCRETE	9000.320224			0,14	37	1740
			MELAMINE / BLACK						
VALSA			finishes	product code	package code	pack. qty	m3	kg	PLN
VALSA 001		H 224 cm W 108 cm D 34 cm Kg 58 m3 0,15 pack.qty. 3	WHITE	9500.316562	9000.316586	1	0,06	21	2750
					9000.316616	1	0,07	28	
					9000.316647	1	0,02	9	
			GREY	9500.316395	9000.316487	1	0,06	21	2750
					9000.316517	1	0,07	29	
				9000.316548	1	0,02	9		
VALSA 002		H 224 cm W 144 cm D 34 cm Kg 77 m3 0,20 pack.qty. 4	WHITE	9500.316579	9000.316586	1	0,06	21	3670
					9000.316616	1	0,07	28	
					9000.316623	1	0,06	20	
					9000.316654	1	0,02	7	
			GREY	9500.316487	9000.316487	1	0,06	21	3670
					9000.316517	1	0,07	29	
				9000.316524	1	0,06	21		
				9000.316555	1	0,02	8		
VALSA 003		H 224 cm W 214 cm D 34 cm Kg 105 m3 0,27 pack.qty. 5	WHITE	9500.316586	9000.316579	1	0,07	29	5010
					9000.316623	1	0,06	20	
					9000.316609	1	0,06	19	
					9000.316630	1	0,07	30	
					9000.316654	1	0,02	7	
			GREY	9500.316494	9000.316395	1	0,07	30	5010
					9000.316524	1	0,06	21	
					9000.316500	1	0,06	19	
		9000.316531	1	0,07	31				
				9000.316555	1	0,02	8		

SHELVING UNITS										
VALSA			finishes	product code	package code	pack. qty	m3	kg	PLN	
VALSA 004		H 224 cm W 182 cm D 34 cm Kg 106 m3 0,30 pack.qty. 6	WHITE	9500.316500	9000.316562	1	0,06	19	5040	
					9000.316623	2	0,06	20		
					9000.316609	2	0,06	19		
				9500.316388	9000.316647	1	0,02	9		
			GREY		9000.316388	1	0,06	20		5040
					9000.316524	2	0,06	21		
	9000.316500	2	0,06	19						
		9000.316548	1	0,02	9					
VALSA 005		H 224 cm W 216 cm D 34 cm Kg 116 m3 0,31 pack.qty. 6	WHITE	9500.316609	9000.316586	1	0,06	21	5400	
					9000.316609	1	0,06	19		
					9000.316623	2	0,06	20		
					9000.316616	1	0,07	28		
				9500.316517	9000.316654	1	0,02	7		
			GREY		9000.316487	1	0,06	21	5400	
					9000.316500	1	0,06	19		
					9000.316524	2	0,06	21		
	9000.316517	1	0,07	29						
		9000.316555	1	0,02	8					
VALSA 007		H 224 cm W 110 cm D 27/34 cm Kg 67 m3 0,19 pack.qty. 4	WHITE	9500.316647	9000.316586	1	0,06	21	3100	
					9000.316609	1	0,06	19		
					9000.316623	1	0,06	20		
					9000.316654	1	0,02	7		
				9500.316555	9000.316487	1	0,06	21	3100	
			GREY		9000.316500	1	0,06	19		
					9000.316524	1	0,06	21		
					9000.316555	1	0,02	8		
 WIND			finishes	product code	package code	pack. qty	m3	kg	PLN	
WIND		H 160 cm W 156 cm D 39 cm Kg 46 m3 0,10 pack.qty. 2	WALNUT	9500.322457	9003.322464	1	0,06	28	2770	
					9003.322471	1	0,04	19		
				9500.321603	OAK	9003.321610	1	0,06	28	2770
					9003.318047	1	0,04	19		
				9500.318054	WHITE / OAK	9000.318054	1	0,06	26	2770
					9003.318047	1	0,04	19		

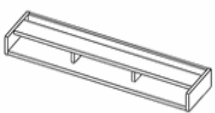



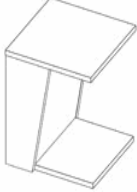
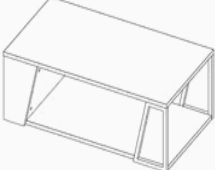

WALL MOUNTED PRODUCTS

BALDA			finishes	product code	package code	pack. qty	m3	kg	PLN	
BALDA 60		H 5 cm W 60 cm D 22 cm Kg 3 m3 0,01 pack.qty. 1	WALNUT	9003.991943			0,01	3	280	
			OAK	9003.991905			0,01	3	280	
			WHITE	9000.991820			0,01	3	240	
BALDA 90		H 5 cm W 90 cm D 22 cm Kg 4 m3 0,01 pack.qty. 1	WALNUT	9003.991950			0,01	4	370	
			OAK	9003.991912			0,01	4	370	
			WHITE	9000.991837			0,01	4	280	
BALDA 120		H 5 cm W 120 cm D 22 cm Kg 7 m3 0,02 pack.qty. 1	WALNUT	9003.991967			0,02	8	430	
			OAK	9003.991929			0,02	8	430	
			WHITE	9000.991844			0,02	8	350	
BERN			finishes	product code	package code	pack. qty	m3	kg	PLN	
BERN 90		H 45 cm W 90 cm D 23 cm Kg 10 m3 0,14 pack.qty. 1	WHITE / PLYWOOD	9000.318078			0,14	10	630	
			BLACK / PLYWOOD	9000.318061			0,14	10	630	
fully assembled product										
	PLY			finishes	product code	package code	pack. qty	m3	kg	PLN
PLY WALL SHELF		H 9 cm W 100 cm D 23 cm Kg 5 m3 0,03 pack.qty. 1	BLACK / PLYWOOD	9300.167591			0,03	6	590	
			fully assembled product							

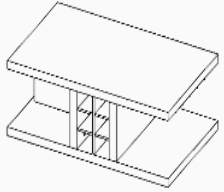
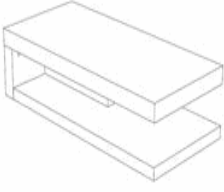



COFFEE AND SIDE TABLES

ALBI		finishes	product code	package code	pack. qty	m3	kg	PLN
ALBI SIDE TABLE		H 46 cm W 40 cm D 40 cm Kg 9 m3 0,02 pack.qty. 1	WALNUT / BLACK	9003.629907		0,02	10	480
			LIGHT OAK / WHITE	9003.629914		0,02	10	480
ALBI COFFEE TABLE		H 36 cm W 100 cm D 55 cm Kg 21 m3 0,04 pack.qty. 1	WALNUT / BLACK	9003.629921		0,04	22	1710
			METAL LIGHT OAK / WHITE	9003.629938		0,04	23	1710
METAL			WALNUT / BLACK	9003.630743		0,09	29	1290
			OAK / WHITE	9003.630736		0,09	29	1290
WHITE			WHITE	9000.630712		0,09	28	1130
			WHITE / PLYWOOD	9000.630729		0,09	28	1130
CONCRETE			CONCRETE	9000.630750		0,09	29	1190
MELAMINE / BLACK			MELAMINE / BLACK					
BRUNO		finishes	product code	package code	pack. qty	m3	kg	PLN
BRUNO SIDE TABLE		H 50 cm W 50 cm D 50 cm Kg 9 m3 0,03 pack.qty. 1	OAK / BLACK	9003.628085		0,03	7	1110
BRUNO COFFEE TABLE		H 42 cm W 80 cm D 80 cm Kg 19 m3 0,07 pack.qty. 1	OAK / BLACK	9003.628078		0,07	14	1560





COFFEE AND SIDE TABLES

DETROIT			finishes	product code	package code	pack. qty	m3	kg	PLN
DETROIT BAR COFFEE TABLE		H 45 cm W 110 cm D 65 cm Kg 44 m3 0,19 pack.qty. 2	CONCRETE	9500.627705	9000.627712	1	0,07	19	2020
			MELAMINE / BLACK		9000.627729	1	0,12	26	
DETROIT COFFEE TABLE		H 29 cm W 110 cm D 65 cm Kg 25 m3 0,16 pack.qty. 1	CONCRETE	9000.625039			0,16	26	1420
			MELAMINE / BLACK						
GLEAM			finishes	product code	package code	pack. qty	m3	kg	PLN
GLEAM 50		H 45 cm W 50 cm D 50 cm Kg 8 m3 0,14 pack.qty. 2	OXIDE / BLACK METAL	9500.626586	9000.626142	1	0,01	4	1120
					9000.625947	1	0,13	5	
			OAK / BLACK METAL	9500.626562	9003.626470	1	0,01	4	1150
					9000.625947	1	0,13	5	
			WALNUT / BLACK METAL	9500.628788	9003.628740	1	0,01	4	1150
					9000.625947	1	0,13	5	
GLEAM 50 KIT		H 45 cm W 50 cm D 50 cm Kg 6 m3 0,04 pack.qty. 1	OXIDE / BLACK METAL	9000.630347			0,04	7	1060
			WALNUT / BLACK METAL	9003.630323			0,04	7	1100
			OAK / CHROME METAL	9003.630316			0,04	7	1420
			WALNUT / CHROME METAL	9003.630330			0,04	7	1420
GLEAM 50 MARBLE		H 45 cm W 50 cm D 50 cm Kg 20 m3 0,18 pack.qty. 2	WHITE MARBLE / BLACK METAL	9500.625985	9000.623004	1	0,05	16	1870
					9000.625947	1	0,13	5	
			BLACK MARBLE / BLACK METAL	9500.625978	9000.623011	1	0,05	16	1870
					9000.625947	1	0,13	5	
			GREEN MARBLE / BLACK METAL	9500.626029	9000.625923	1	0,05	16	1870
					9000.625947	1	0,13	5	
GLEAM 50 MARBLE		H 45 cm W 50 cm D 50 cm Kg 20 m3 0,18 pack.qty. 2	WHITE MARBLE / CHROME METAL	9500.626081	9000.623004	1	0,05	16	2210
					9000.626036	1	0,13	5	
			BLACK MARBLE / CHROME METAL	9500.626074	9000.623011	1	0,05	16	2210
					9000.626036	1	0,13	5	
GLEAM 50 MARBLE		H 45 cm W 50 cm D 50 cm Kg 20 m3 0,18 pack.qty. 2	GREEN MARBLE / CHROME METAL	9500.626449	9000.625923	1	0,05	16	2210
					9000.626036	1	0,13	5	





COFFEE AND SIDE TABLES

GLEAM		finishes	product code	package code	pack. qty	m3	kg	PLN	
GLEAM 50 MARBLE KIT		H 45 cm	WHITE MARBLE /	9500.630064	9000.623004	1	0,05	16	1770
		W 50 cm	BLACK METAL		9000.629983	1	0,03	3	
		D 50 cm	BLACK MARBLE /	9500.630088	9000.623011	1	0,05	16	1770
		Kg 19	BLACK METAL		9000.629983	1	0,03	3	
		m3 0,08	GREEN MARBLE /	9500.630101	9000.625923	1	0,05	16	1770
		pack.qty. 2	BLACK METAL		9000.629983	1	0,03	3	
			WHITE MARBLE /	9500.630071	9000.623004	1	0,05	16	2120
	CHROME METAL		9000.629990	1	0,03	3			
	BLACK MARBLE /	9500.630095	9000.623011	1	0,05	16	2120		
	CHROME METAL		9000.629990	1	0,03	3			
	GREEN MARBLE /	9500.630118	9000.625923	1	0,05	16	2120		
	CHROME METAL		9000.629990	1	0,03	3			
GLEAM 75		H 40 cm	OXIDE / BLACK	9500.626623	9000.626166	1	0,02	8	1350
		W 75 cm	METAL		9000.625961	1	0,23	6	
		D 75 cm	OAK / BLACK	9500.626609	9003.626494	1	0,02	8	1400
		Kg 14	METAL		9000.625961	1	0,23	6	
		m3 0,25	WALNUT / BLACK	9500.628795	9003.628757	1	0,02	9	1400
pack.qty. 2	METAL		9000.625961	1	0,23	6			
	OAK / CHROME	9500.626630	9003.626494	1	0,02	8	1840		
	METAL		9000.626043	1	0,23	5			
	WALNUT / CHROME	9500.629037	9003.628757	1	0,02	9	1840		
	METAL		9000.626043	1	0,23	5			
GLEAM 75 KIT		H 40 cm	OXIDE / BLACK	9000.630392			0,09	13	1290
		W 75 cm	METAL						
		D 75 cm	OAK / BLACK	9003.630354			0,09	13	1330
		Kg 12	METAL						
		m3 0,09	WALNUT / BLACK	9003.630378			0,09	13	1330
pack.qty. 1	METAL								
	OAK / CHROME	9003.630361			0,09	13	1710		
	METAL								
	WALNUT / CHROME	9003.630385			0,09	13	1710		
	METAL								
GLEAM 75 MARBLE		H 40 cm	WHITE MARBLE /	9500.626180	9000.623066	1	0,11	40	2840
		W 75 cm	BLACK METAL		9000.625961	1	0,23	6	
		D 75 cm	BLACK MARBLE /	9500.626173	9000.623073	1	0,11	40	2840
		Kg 45	BLACK METAL		9000.625961	1	0,23	6	
		m3 0,34	GREEN MARBLE /	9500.626197	9000.626067	1	0,11	40	2840
		pack.qty. 2	BLACK METAL		9000.625961	1	0,23	6	
			WHITE MARBLE /	9500.626210	9000.623066	1	0,11	40	3280
	CHROME METAL		9000.626043	1	0,23	5			
	BLACK MARBLE /	9500.626203	9000.623073	1	0,11	40	3280		
	CHROME METAL		9000.626043	1	0,23	5			
	GREEN MARBLE /	9500.626227	9000.626067	1	0,11	40	3280		
	CHROME METAL		9000.626043	1	0,23	5			





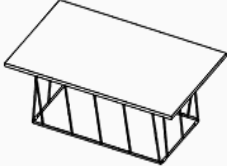
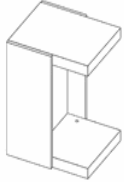

COFFEE AND SIDE TABLES

GLEAM		finishes	product code	package code	pack. qty	m3	kg	PLN	
GLEAM 75 MARBLE KIT		H 40 cm	WHITE MARBLE /	9500.630125	9000.623066	1	0,11	40	2710
		W 75 cm	BLACK METAL		9000.630002	1	0,07	5	
		D 75 cm	BLACK MARBLE /	9500.630149	9000.623073	1	0,11	40	2710
		Kg 44	BLACK METAL		9000.630002	1	0,07	5	
		m3 0,18	GREEN MARBLE /	9500.630163	9000.626067	1	0,11	40	2710
		pack.qty. 2	BLACK METAL		9000.630002	1	0,07	5	
			WHITE MARBLE /	9500.630132	9000.623066	1	0,11	40	3120
	CHROME METAL		9000.630019	1	0,07	5			
		BLACK MARBLE /	9500.630156	9000.623073	1	0,11	40	3120	
		CHROME METAL		9000.630019	1	0,07	5		
		GREEN MARBLE /	9500.630170	9000.626067	1	0,11	40	3120	
		CHROME METAL		9000.630019	1	0,07	5		
GLEAM 120		H 40 cm	OXIDE / BLACK	9500.626661	9000.626500	1	0,03	13	1890
		W 120 cm	METAL		9000.625954	1	0,36	6	
		D 75 cm	OAK / BLACK	9500.626647	9003.626524	1	0,03	13	1970
		Kg 18	METAL		9000.625954	1	0,36	6	
		m3 0,40	WALNUT / BLACK	9500.628801	9003.628764	1	0,03	13	1970
pack.qty. 2	METAL		9000.625954	1	0,36	6			
		OAK / CHROME	9500.626678	9003.626524	1	0,03	13	2520	
		METAL		9000.626050	1	0,36	6		
		WALNUT / CHROME	9500.629044	9003.628764	1	0,03	13	2520	
		METAL		9000.626050	1	0,36	6		
GLEAM 120 KIT		H 40 cm	OXIDE / BLACK	9000.630446			0,14	19	1800
		W 120 cm	METAL						
		D 75 cm	OAK / BLACK	9003.630408			0,14	19	1880
		Kg 18	METAL						
		m3 0,14	WALNUT / BLACK	9003.630422			0,14	19	1880
pack.qty. 1	METAL								
		OAK / CHROME	9003.630415			0,14	19	2350	
		METAL							
		WALNUT / CHROME	9003.630439			0,14	19	2350	
		METAL							
GLEAM 120 MARBLE		H 40 cm	WHITE MARBLE /	9500.626005	9000.623080	1	0,16	63	4220
		W 120 cm	BLACK METAL		9000.625954	1	0,36	6	
		D 75 cm	BLACK MARBLE /	9500.625992	9000.623097	1	0,16	63	4220
		Kg 69	BLACK METAL		9000.625954	1	0,36	6	
		m3 0,53	GREEN MARBLE /	9500.626012	9000.625930	1	0,16	63	4220
		pack.qty. 2	BLACK METAL		9000.625954	1	0,36	6	
			WHITE MARBLE /	9500.626456	9000.623080	1	0,16	63	4770
	CHROME METAL		9000.626050	1	0,36	6			
		BLACK MARBLE /	9500.626098	9000.623097	1	0,16	63	4770	
		CHROME METAL		9000.626050	1	0,36	6		
		GREEN MARBLE /	9500.626104	9000.625930	1	0,16	63	4770	
		CHROME METAL		9000.626050	1	0,36	6		

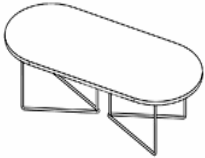

COFFEE AND SIDE TABLES

GLEAM			finishes	product code	package code	pack. qty	m3	kg	PLN
GLEAM 120 MARBLE KIT		H 40 cm W 120 cm D 75 cm Kg 70 m3 0,27 pack.qty. 2	WHITE MARBLE / BLACK METAL	9500.630187	9000.623080	1	0,16	63	4040
					9000.630026	1	0,11	7	
			BLACK MARBLE / BLACK METAL	9500.630200	9000.623097	1	0,16	63	4040
					9000.630026	1	0,11	7	
			GREEN MARBLE / BLACK METAL	9500.630224	9000.625930	1	0,16	63	4040
					9000.630026	1	0,11	7	
			WHITE MARBLE / CHROME METAL	9500.630194	9000.623080	1	0,16	63	4560
		9000.630033	1	0,11	7				
		BLACK MARBLE / CHROME METAL	9500.630217	9000.623097	1	0,16	63	4560	
				9000.630033	1	0,11	7		
		GREEN MARBLE / CHROME METAL	9500.630231	9000.625930	1	0,16	63	4560	
				9000.630033	1	0,11	7		
HELIX			finishes	product code	package code	pack. qty	m3	kg	PLN
HELIX 50 MARBLE		H 47 cm W 50 cm D 50 cm Kg 21 m3 0,11 pack.qty. 2	WHITE MARBLE / BLACK METAL	9500.627316	9000.627231	1	0,05	18	1750
					9000.626746	1	0,05	4	
			BLACK MARBLE / BLACK METAL	9500.627323	9000.627248	1	0,05	18	1750
				9000.626746	1	0,05	4		
		GREEN MARBLE / BLACK METAL	9500.627330	9000.627255	1	0,05	18	1750	
				9000.626746	1	0,05	4		
HELIX 120 MARBLE		H 42 cm W 120 cm D 75 cm Kg 69 m3 0,36 pack.qty. 2	WHITE MARBLE / BLACK METAL	9500.627415	9000.623080	1	0,16	63	4170
					9000.626784	1	0,20	6	
			BLACK MARBLE / BLACK METAL	9500.627422	9000.623097	1	0,16	63	4170
				9000.626784	1	0,20	6		
		GREEN MARBLE / BLACK METAL	9500.627439	9000.625930	1	0,16	63	4170	
				9000.626784	1	0,20	6		
KLAUS			finishes	product code	package code	pack. qty	m3	kg	PLN
KLAUS SIDE TABLE		H 55 cm W 38 cm D 45 cm Kg 12 m3 0,05 pack.qty. 1	CONCRETE MELAMINE / BLACK	9000.627804			0,05	13	640
NINA			finishes	product code	package code	pack. qty	m3	kg	PLN
NINA COFFEE TABLE		H 45 cm W 100 cm D 55 cm Kg 25 m3 0,08 pack.qty. 1	LIGHT OAK / BLACK	9003.629945			0,08	25	1660
			LIGHT OAK / WHITE	9003.629952			0,08	26	1660

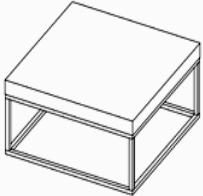
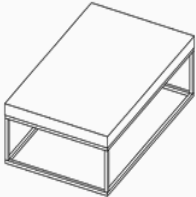

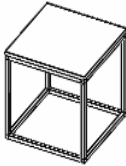
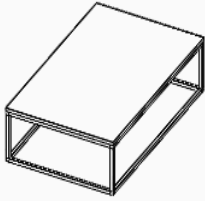

COFFEE AND SIDE TABLES

 NORA		finishes	product code	package code	pack. qty	m3	kg	PLN	
NORA SOFA TABLE		H 64 cm W 50 cm D 50 cm Kg 11 m3 0,03 pack.qty. 1	WALNUT	9003.629969			0,03	11	720
			LIGHT OAK	9003.630651			0,03	11	720
NORA COFFEE TABLE		H 51 cm W 110 cm D 50 cm Kg 21 m3 0,05 pack.qty. 1	WALNUT	9003.630644			0,05	24	1070
			LIGHT OAK	9003.630668			0,05	25	1070
 OVAL		finishes	product code	package code	pack. qty	m3	kg	PLN	
OVAL COFFEE TABLE		H 36 cm W 136 cm D 60 cm Kg 18 m3 0,11 pack.qty. 2	LIGHT OAK / BLACK	9500.629730	9003.629747	1	0,03	13	1210
			METAL		9000.629723	1	0,08	5	
			WALNUT / BLACK	9500.629709	9003.629716	1	0,03	13	1210
			METAL		9000.629723	1	0,08	5	
PETRA		finishes	product code	package code	pack. qty	m3	kg	PLN	
PETRA 55		H 53 cm W 55 cm D 55 cm Kg 13 m3 0,06 pack.qty. 1	CONCRETE MELAMINE / BLACK METAL	9000.629341			0,06	14	1130
PETRA 75		H 38 cm W 75 cm D 75 cm Kg 16 m3 0,10 pack.qty. 1	CONCRETE MELAMINE / BLACK METAL	9000.629358			0,10	17	1240
PETRA 120		H 38 cm W 120 cm D 75 cm Kg 22 m3 0,15 pack.qty. 1	CONCRETE MELAMINE / BLACK METAL	9000.629365			0,15	23	1330

COFFEE AND SIDE TABLES

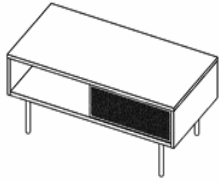
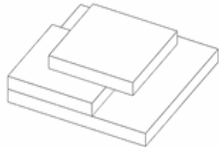
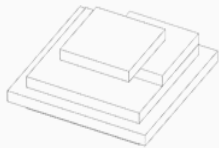
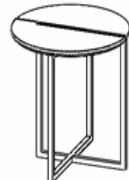

PLY		finishes	product code	package code	pack. qty	m3	kg	PLN	
PLY 50		H 45 cm W 50 cm D 50 cm Kg 6 m3 0,03 pack.qty. 1	LIGHT OAK / BLACK METAL	9003.628719		0,03	6	920	
		WALNUT / BLACK METAL	9003.629136		0,03	6	920		
PLY 70		H 45 cm W 70 cm D 70 cm Kg 9 m3 0,07 pack.qty. 1	LIGHT OAK / BLACK METAL	9003.628726		0,07	10	1110	
		WALNUT / BLACK METAL	9003.629143		0,07	10	1110		
PLY 80		H 35 cm W 80 cm D 80 cm Kg 11 m3 0,09 pack.qty. 1	LIGHT OAK / BLACK METAL	9003.628733		0,09	12	1200	
		WALNUT / BLACK METAL	9003.629150		0,09	12	1200		
PRAIRIE		finishes	product code	package code	pack. qty	m3	kg	PLN	
PRAIRIE 50 MARBLE		H 47 cm W 50 cm D 50 cm Kg 19 m3 0,07 pack.qty. 2	WHITE MARBLE / BLACK METAL	9500.625015	9000.623004	1	0,05	16	1530
					9000.312519	1	0,02	4	
			BLACK MARBLE / BLACK METAL	9500.623011	9000.623011	1	0,05	16	1530
					9000.312519	1	0,02	4	
			GREEN MARBLE / BLACK METAL	9500.626722	9000.625923	1	0,05	16	1530
					9000.312519	1	0,02	4	
			WHITE MARBLE / CHROME METAL	9500.625053	9000.623004	1	0,05	16	1820
		9000.623820	1	0,02	4				
PRAIRIE 120 MARBLE		H 32 cm W 120 cm D 75 cm Kg 73 m3 0,22 pack.qty. 2	WHITE MARBLE / BLACK METAL	9500.625046	9000.623080	1	0,16	63	3750
					9000.312663	1	0,06	10	
			BLACK MARBLE / BLACK METAL	9500.623097	9000.623097	1	0,16	63	3750
					9000.312663	1	0,06	10	
			GREEN MARBLE / BLACK METAL	9500.626692	9000.625930	1	0,16	63	3750
					9000.312663	1	0,06	10	
			WHITE MARBLE / CHROME METAL	9500.624919	9000.623080	1	0,16	63	4250
		9000.623875	1	0,06	10				
		9000.623097	1	0,16	63	4250			
		9000.623875	1	0,06	10				
		9000.625930	1	0,16	63	4250			
		9000.623875	1	0,06	10				

COFFEE AND SIDE TABLES

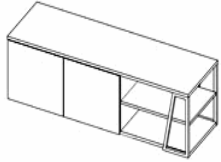
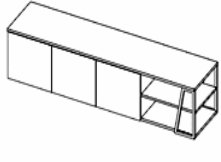
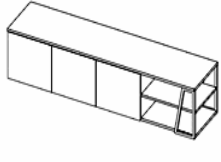
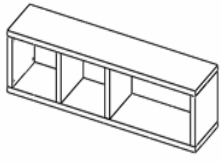
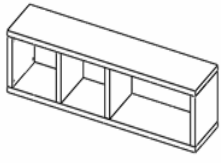
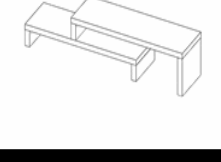
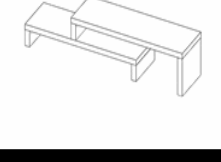
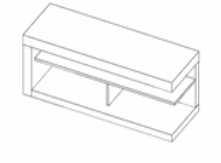
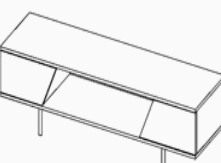

RADIO		finishes	product code	package code	pack. qty	m3	kg	PLN	
RADIO COFFEE TABLE 100		H 40 cm W 100 cm D 50 cm Kg 19 m3 0,07 pack.qty. 1	WALNUT / BLACK	9003.630583		0,07	20	1550	
			WALNUT / WHITE	9003.630606		0,07	20	1550	
			OAK / BLACK	9003.630590		0,07	20	1550	
			OAK / WHITE	9003.630613		0,07	20	1550	
SLATE		finishes	product code	package code	pack. qty	m3	kg	PLN	
SLATE COFFEE TABLE 90		H 30 cm W 90 cm D 90 cm Kg 45 m3 0,24 pack.qty. 2	WHITE	9500.311819	9000.311987	1	0,07	17	2120
					9000.311819	1	0,17	28	
			WHITE / OAK	9500.625237	9000.311987	1	0,07	17	2120
					9003.625237	1	0,17	28	
SLATE COFFEE TABLE 110		H 37 cm W 110 cm D 110 cm Kg 87 m3 0,33 pack.qty. 3	CONCRETE	9500.630675	9000.630682	1	0,06	18	2500
			MELAMINE / BLACK		9000.630699	1	0,15	40	
					9000.630705	1	0,12	28	
SONATA		finishes	product code	package code	pack. qty	m3	kg	PLN	
SONATA SIDE TABLE 50		H 50 cm W 50 cm D 50 cm Kg 14 m3 0,06 pack.qty. 1	LIGHT OAK / WHITE	9003.629204		0,06	15	1850	
			MARBLE						
SONATA COFFEE TABLE 80		H 40 cm W 80 cm D 80 cm Kg 27 m3 0,09 pack.qty. 1	WALNUT / BLACK	9003.629211		0,06	14	1850	
			MARBLE						
SONATA COFFEE TABLE 80		H 40 cm W 80 cm D 80 cm Kg 27 m3 0,09 pack.qty. 1	LIGHT OAK / WHITE	9003.629228		0,09	28	3000	
			MARBLE						
SONATA COFFEE TABLE 80		H 40 cm W 80 cm D 80 cm Kg 27 m3 0,09 pack.qty. 1	WALNUT / BLACK	9003.629235		0,09	28	3000	
			MARBLE						

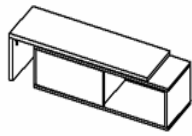
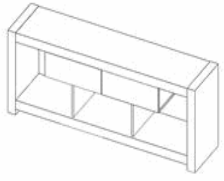
TV STANDS									
ALBI		finishes	product code	package code	pack. qty	m3	kg	PLN	
ALBI TV STAND 145		H 45 cm W 145 cm D 45 cm Kg 43 m3 0,10 pack.qty. 2	LIGHT OAK / WHITE	9500.639821	9003.639838	1	0,07	34	2820
			METAL		9000.639845	1	0,03	10	
ALBI TV STAND 190		H 45 cm W 190 cm D 45 cm Kg 56 m3 0,13 pack.qty. 2	LIGHT OAK / WHITE	9500.639869	9003.639906	1	0,08	38	3390
			METAL		9003.639913	1	0,05	19	
ALBI TV STAND 190		H 45 cm W 190 cm D 45 cm Kg 56 m3 0,13 pack.qty. 2	WALNUT / BLACK	9500.639876	9003.639883	1	0,08	37	3390
			METAL		9003.639890	1	0,05	19	
BERLIN		finishes	product code	package code	pack. qty	m3	kg	PLN	
BERLIN TV STAND 150		H 45 cm W 150 cm D 34 cm Kg 22 m3 0,07 pack.qty. 1	WALNUT	9003.639753			0,07	22	1520
			OAK	9003.639746			0,07	23	1520
			CONCRETE MELAMINE	9000.639760			0,07	23	1200
			WHITE	9000.639722			0,07	21	1200
BERLIN TV STAND 150		H 45 cm W 150 cm D 34 cm Kg 22 m3 0,07 pack.qty. 1	WHITE / PLYWOOD	9000.639739			0,07	21	1200
CLIFF		finishes	product code	package code	pack. qty	m3	kg	PLN	
CLIFF TV STAND 120/120		H 20/40 cm W 125/235 cm D 38 cm Kg 23 m3 0,11 pack.qty. 1	WALNUT	9003.638633			0,11	24	1390
			WHITE / WALNUT	9003.638251			0,11	24	1260
			WHITE	9000.639265			0,11	23	1120
			CONCRETE MELAMINE / BLACK	9000.639579			0,11	25	1120
CLIFF TV STAND 120/120		H 20/40 cm W 125/235 cm D 38 cm Kg 23 m3 0,11 pack.qty. 1							
DETROIT		finishes	product code	package code	pack. qty	m3	kg	PLN	
DETROIT TV STAND 130		H 45 cm W 130 cm D 45 cm Kg 34 m3 0,22 pack.qty. 1	CONCRETE MELAMINE / BLACK	9000.638800			0,22	35	1680
DIXIE		finishes	product code	package code	pack. qty	m3	kg	PLN	
DIXIE TV STAND 140		H 51 cm W 140 cm D 40 cm Kg 29 m3 0,06 pack.qty. 1	WALNUT / BLACK	9003.639289			0,06	30	1760
			OAK / WHITE	9003.639777			0,06	30	1760

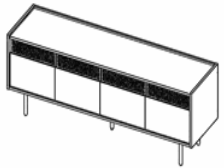

TV STANDS

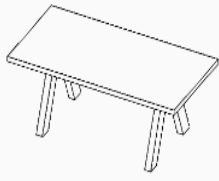
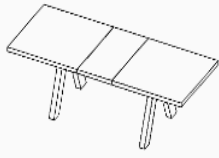
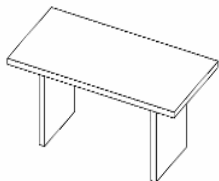
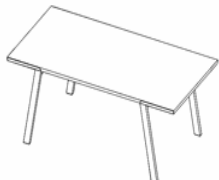
MOVE			finishes	product code	package code	pack. qty	m3	kg	PLN
MOVE TV STAND 203/110		H 32 cm W 203/110 cm D 35 cm Kg 24 m3 0,07 pack.qty. 1	WALNUT / GREY	9003.638244			0,07	24	1540
			WHITE / PLYWOOD	9000.639197			0,07	23	1540
			WALNUT / WHITE	9003.639180			0,07	24	1540
			CONCRETE MELAMINE / BLACK	9000.639784			0,07	24	1540
NARA			finishes	product code	package code	pack. qty	m3	kg	PLN
NARA TV STAND 174		H 66 cm W 174 cm D 41 cm Kg 60 m3 0,31 pack.qty. 2	CONCRETE	9500.638787	9000.638787	1	0,25	36	2880
			MELAMINE / BLACK		9000.638794	1	0,06	24	
NINA			finishes	product code	package code	pack. qty	m3	kg	PLN
NINA TV STAND 140		H 59 cm W 140 cm D 42 cm Kg 42 m3 0,12 pack.qty. 1	LIGHT OAK / BLACK	9003.639548			0,12	42	2200
			LIGHT OAK / WHITE	9003.639555			0,12	42	2200
RADIO			finishes	product code	package code	pack. qty	m3	kg	PLN
RADIO TV STAND 160		H 60 cm W 160 cm D 43 cm Kg 48 m3 0,11 pack.qty. 2	OAK / WHITE	9500.639630					2780
			OAK / BLACK	9500.639586					2780
			WALNUT / WHITE	9500.639661					2780
			WALNUT / BLACK	9500.639616					2780

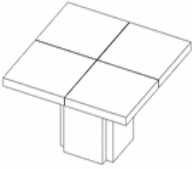
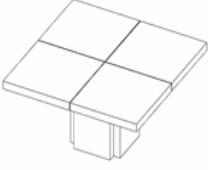
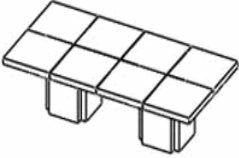
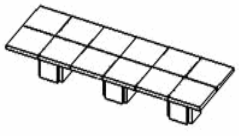

DINING TABLES

APEX		finishes	product code	package code	pack. qty	m3	kg	PLN	
APEX 200		H 76 cm W 200 cm D 100 cm Kg 61 m3 0,22 pack.qty. 2	CONCRETE MELAMINE / BLACK	9500.612893	9000.612893 9000.612831	1 1	0,15 0,07	28 33	3120
APEX 200 EXTENDIBLE		H 76 cm W 250/200 cm D 100 cm Kg 77 m3 0,28 pack.qty. 3	CONCRETE MELAMINE / BLACK	9500.613173	9000.612817 9000.612831 9000.613173	1 1 1	0,17 0,07 0,04	37 33 8	4470
DETROIT		finishes	product code	package code	pack. qty	m3	kg	PLN	
DETROIT 160		H 75 cm W 160 cm D 80 cm Kg 35 m3 0,19 pack.qty. 1	CONCRETE MELAMINE / BLACK	9000.613494			0,19	35	1620
DRIFT		finishes	product code	package code	pack. qty	m3	kg	PLN	
DRIFT 180		H 75 cm W 180 cm D 91 cm Kg 41 m3 0,15 pack.qty. 2	LIGHT OAK / BLACK METAL WALNUT / BLACK METAL	9500.614088	9000.614095 9003.614101 9000.614095 9003.614125	1 1 1 1	0,06 0,09 0,06 0,09	15 26 15 25	2990
DRIFT 200		H 75 cm W 200 cm D 100 cm Kg 46 m3 0,17 pack.qty. 2	LIGHT OAK / BLACK METAL WALNUT / BLACK METAL	9500.614453	9000.614439 9003.614507 9000.614439 9003.614446	1 1 1 1	0,08 0,09 0,08 0,09	16 31 16 31	4290

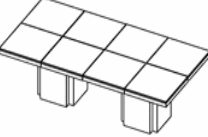
DINING TABLES

DUSK		finishes	product code	package code	pack. qty	m3	kg	PLN	
DUSK 130		H 75 cm W 130 cm D 130 cm Kg 69 m3 0,32 pack.qty. 2	CHOCOLATE	9500.620904	9003.620911	1	0,18	32	4390
					9003.620904	1	0,14	38	
			HIGH GLOSS WHITE	9500.612602	9000.612596	1	0,18	31	4830
					9000.612602	1	0,14	38	
			CONCRETE	9500.613234	9000.613234	1	0,18	31	3950
			MELAMINE / BLACK		9000.613241	1	0,14	38	
DUSK 150		H 75 cm W 150 cm D 150 cm Kg 77 m3 0,36 pack.qty. 2	CHOCOLATE	9500.620928	9003.620911	1	0,18	32	5240
					9003.620928	1	0,18	46	
			HIGH GLOSS WHITE	9500.612619	9000.612596	1	0,18	31	5770
					9000.612619	1	0,18	46	
			CONCRETE	9500.613265	9000.613234	1	0,18	31	4720
			MELAMINE / BLACK		9000.613265	1	0,18	46	
DUSK 002		H 75 cm W 262 cm D 130 cm Kg 140 m3 0,67 pack.qty. 4	CHOCOLATE	9500.613203	9003.620911	2	0,18	32	8770
					9003.620904	1	0,14	38	
					9003.613203	1	0,16	39	
			HIGH GLOSS WHITE	9500.613180	9000.612596	2	0,18	31	9640
					9000.612602	1	0,14	38	
					9000.613180	1	0,16	39	
			CONCRETE	9500.613241	9000.613234	2	0,18	31	7900
			MELAMINE / BLACK		9000.613241	1	0,14	38	
DUSK 003		H 75 cm W 392 cm D 130 cm Kg 211 m3 1,01 pack.qty. 6	CHOCOLATE	9500.613210	9003.620911	3	0,18	32	13150
					9003.620904	1	0,14	38	
					9003.613203	2	0,16	39	
			HIGH GLOSS WHITE	9500.613197	9000.612596	3	0,18	31	14450
					9000.612602	1	0,14	38	
					9000.613180	2	0,16	39	
			CONCRETE	9500.613258	9000.613234	3	0,18	31	11850
			MELAMINE / BLACK		9000.613241	1	0,14	38	
DUSK 130 MARBLE		H 76 cm W 130 cm D 130 cm Kg 211 m3 0,43 pack.qty. 6	WHITE MARBLE /	9500.628009	9000.627965	1	0,19	34	10250
			WHITE		9000.627972	1	0,10	33	
					9000.627927	4	0,03	36	
DUSK 002 MARBLE		H 76 cm W 262 cm D 130 cm Kg 422 m3 0,86 pack.qty. 12	WHITE MARBLE /	9500.628054	9000.627965	2	0,19	34	19960
			WHITE		9000.627972	1	0,10	33	
					9000.627927	8	0,03	36	
					9000.628030	1	0,11	33	

DINING TABLES

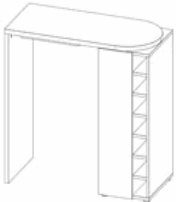

BRAND		LAGO		finishes	product code	package code	pack. qty	m3	kg	PLN
LAGO 180		H 75 cm W 180 cm D 100 cm Kg 45 m3 0,16 pack.qty. 1	WALNUT / BLACK	9003.614408				0,16	45	3270
			LIGHT OAK / BLACK	9003.614415				0,16	46	3270
LAGO180 MARBLE		H 75 cm W 180 cm D 100 cm Kg 58 m3 0,20 pack.qty. 2	WALNUT / BLACK	9500.614286	9003.614293	1	0,16	40	4090	
			MARBLE		9000.614309	1	0,04	19		
			LIGHT OAK / WHITE	9500.614316	9003.614323	1	0,16	40	4090	
			MARBLE		9000.614330	1	0,04	19		

BAR TABLES

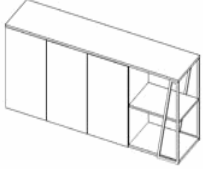
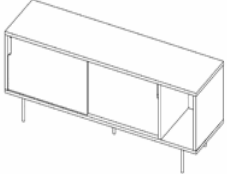
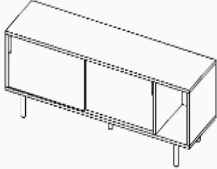
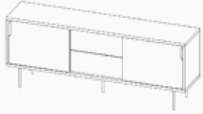
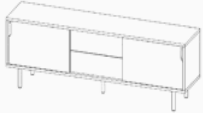
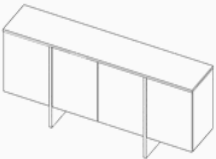
BRAND	ROLL		finishes	product code	package code	pack. qty	m3	kg	PLN
ROLL ROTATING BAR TABLE		H 99 cm W 110 cm D 50 cm Kg 49 m3 0,12 pack.qty. 2	LIGHT OAK	9500.970016	9000.970023	1	0,07	36	1890
			MELAMINE / WHITE		9000.970030	1	0,04	14	
			LIGHT OAK	9500.970047	9000.970054	1	0,07	35	1890
			MELAMINE / BLACK		9000.970030	1	0,04	14	



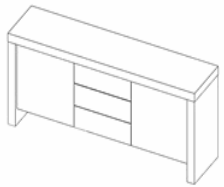
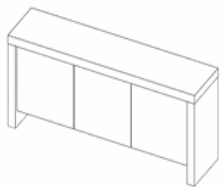
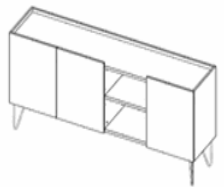

SIDEBOARDS										
ALBI		finishes	product code	package code	pack. qty	m3	kg	PLN		
ALBI SIDEBOARD		H 81 cm W 190 cm D 45 cm Kg 72 m3 0,15 pack.qty. 3	LIGHT OAK / WHITE	9500.405679	9003.405686	1	0,06	28	4380	
			METAL		9003.405693	1	0,05	24		
					9000.405709	1	0,04	21		
		WALNUT / BLACK	9500.405631	9003.405648	1	0,06	27	4380		
					METAL	9003.405655	1		0,05	24
						9000.405662	1		0,04	21
DANN		finishes	product code	package code	pack. qty	m3	kg	PLN		
DANN 165 - METALIC LEGS		H 65 cm W 165 cm D 45 cm Kg 51 m3 0,12 pack.qty. 3	OAK / WHITE	9500.400506	9003.400506	1	0,09	43	2800	
					9000.400520	1	0,03	8		
					9000.400551	1	0,00	1		
		OAK / GREY/ WHITE	9500.400513	9003.400506	1	0,09	43	2800		
						9000.400513	1		0,03	7
						9000.400551	1		0,00	1
DANN 165 - WOODEN LEGS		H 65 cm W 165 cm D 45 cm Kg 51 m3 0,12 pack.qty. 3	OAK / WHITE	9500.400520	9003.400506	1	0,09	43	3190	
					9000.400520	1	0,03	8		
					9003.400537	1	0,01	1		
		OAK / GREY/ WHITE	9500.400537	9003.400506	1	0,09	43	3190		
						9000.400513	1		0,03	7
						9003.400537	1		0,01	1
DANN 201 - METALIC LEGS		H 65 cm W 201 cm D 45 cm Kg 61 m3 0,14 pack.qty. 3	OAK / WHITE	9500.401688	9003.401695	1	0,05	23	3360	
					9003.401466	1	0,06	31		
					9000.400520	1	0,03	8		
		OAK / GREY/ WHITE	9500.401701	9003.401695	1	0,05	23	3360		
						9003.401466	1		0,06	31
						9000.400513	1		0,03	7
DANN 201 - WOODEN LEGS		H 65 cm W 201 cm D 45 cm Kg 61 m3 0,14 pack.qty. 3	OAK / WHITE	9500.400933	9003.401459	1	0,05	23	3750	
					9003.401466	1	0,06	31		
					9000.400520	1	0,03	8		
		OAK / GREY/ WHITE	9500.401480	9003.401459	1	0,05	23	3750		
						9003.401466	1		0,06	31
						9000.400513	1		0,03	7
EDGE		finishes	product code	package code	pack. qty	m3	kg	PLN		
EDGE 200		H 76 cm W 200 cm D 42 cm Kg 63 m3 0,17 pack.qty. 3	WHITE / OAK	9500.621697	9003.621697	1	0,06	23	3850	
					9000.621796	1	0,08	30		
					9000.621338	1	0,03	11		
		WHITE / WALNUT	9500.621680	9003.621680	1	0,06	23	3850		
						9000.621796	1		0,08	30
						9000.621338	1		0,03	11

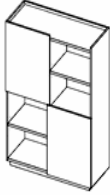

SIDEBOARDS

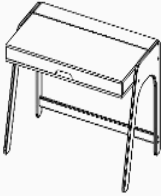

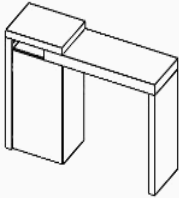
KOBE			finishes	product code	package code	pack. qty	m3	kg	PLN
KOBE 3 DRAWERS, 2 DOORS		H 79 cm W 188 cm D 45 cm Kg 72 m3 0,31 pack.qty. 3	CONCRETE	9500.402135	9000.402142	1	0,12	21	3760
			MELAMINE / BLACK		9000.402159	1	0,10	28	
					9000.402166	1	0,10	23	
KOBE 3 DOORS		H 79 cm W 188 cm D 45 cm Kg 59 m3 0,24 pack.qty. 2	CONCRETE	9500.400308	9000.400308	1	0,16	34	3360
			MELAMINE / BLACK		9000.400315	1	0,08	25	
NINA			finishes	product code	package code	pack. qty	m3	kg	PLN
NINA SIDEBOARD		H 83 cm W 180 cm D 42 cm Kg 75 m3 0,27 pack.qty. 2	LIGHT OAK / BLACK	9500.404139	9000.404146	1	0,19	40	2970
					9003.404153	1	0,09	35	
			LIGHT OAK / WHITE	9500.404160	9000.404177	1	0,19	41	2970
					9003.404153	1	0,09	35	
RADIO			finishes	product code	package code	pack. qty	m3	kg	PLN
RADIO SIDEBOARD		H 77 cm W 160 cm D 43 cm Kg 66 m3 0,13 pack.qty. 3	OAK / BLACK	9500.406034	9003.406041	1	0,03	22	3820
					9000.639609	1	0,04	17	
					9003.406058	1	0,06	28	
			OAK / WHITE	9500.406096	9003.406102	1	0,03	21	3820
					9000.639654	1	0,04	18	
					9003.406119	1	0,06	25	
			WALNUT / BLACK	9500.406065	9003.406072	1	0,03	22	3820
					9000.639609	1	0,04	17	
					9003.406089	1	0,06	28	
			WALNUT / WHITE	9500.406126	9003.406133	1	0,03	21	3820
		9000.639654	1	0,04	18				
		9003.406140	1	0,06	25				
VINY			finishes	product code	package code	pack. qty	m3	kg	PLN
VINY SIDEBOARD		H 80 cm W 100 cm D 42 cm Kg 36 m3 0,07 pack.qty. 1	OAK	9003.407093			0,07	36	1790
			OAK / BLACK	9003.407109				0,07	36



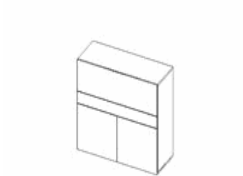
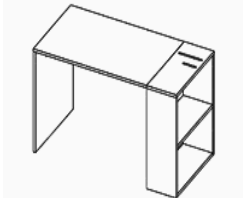
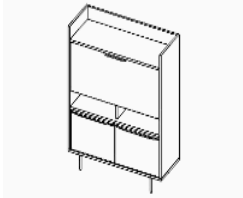

CUPBOARD

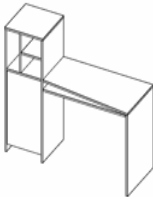
BRAND		NINA		finishes	product code	package code	pack. qty	m3	kg	PLN
NINA CUPBOARD		H 147 cm W 100 cm D 42 cm Kg 85 m3 0,20 pack.qty. 3	LIGHT OAK / WHITE	9500.406973	9000.406980	1	0,09	29	2920	
					9000.406997	1	0,05	26		
					9003.407000	1	0,06	31		
			LIGHT OAK / BLACK	9500.407017	9000.407024	1	0,09	28	2920	
					9000.407031	1	0,05	25		
					9003.407000	1	0,06	31		



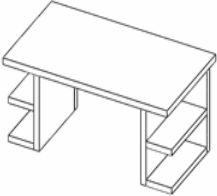
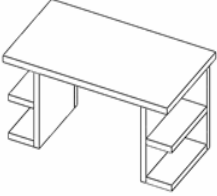

AURA		finishes		product code	package code	pack. qty	m3	kg	PLN
AURA		H 76 cm W 94 cm D 53 cm Kg 20 m3 0,11 pack.qty. 1	OAK / BLACK	9003.053252			0,11	2	2400
			OAK / WHITE	9003.053658			0,11	16	2400
BRISTOL		finishes		product code	package code	pack. qty	m3	kg	PLN
BRISTOL		H 76 cm W 110 cm D 50 cm Kg 22 m3 0,07 pack.qty. 1	LIGHT OAK / WHITE METAL	9003.054280			0,07	22	1680
CITY		finishes		product code	package code	pack. qty	m3	kg	PLN
CITY		H 78 cm W 130 cm D 50 cm Kg 30 m3 0,09 pack.qty. 2	LIGHT OAK / BLACK METAL	9500.053955	9000.053863 9003.053962	1 1	0,04 0,05	8 22	2190
			WALNUT / BLACK METAL	9500.053856	9000.053863 9003.053825	1 1	0,04 0,05	8 22	2190
DETROIT		finishes		product code	package code	pack. qty	m3	kg	PLN
DETROIT		H 82 cm W 119 cm D 35 cm Kg 31 m3 0,16 pack.qty. 2	CONCRETE MELAMINE / BLACK	9500.052835	9000.052835 9000.052842	1 1	0,07 0,08	14 17	1670
FIORE		finishes		product code	package code	pack. qty	m3	kg	PLN
FIORE		H 87 cm W 91 cm D 49 cm Kg 20 m3 0,05 pack.qty. 1	OAK / WHITE	9003.054242			0,05	20	1630

HOME OFFICE						
FLOW			finishes	product code	package code	pack. m3 kg PLN qty
FLOW		H 75 cm W 140 cm D 75 cm Kg 16 m3 0,25 pack.qty. 2	OAK / GREEN METAL	9500.053245	9003.053184	1 0,07 15 1490
					9000.053191	1 0,18 2
			OAK / BLACK METAL	9500.053221	9003.053184	1 0,07 15 1490
					9000.053207	1 0,18 2
			WHITE / PLYWOOD / BLACK METAL	9500.053214	9000.053177	1 0,07 15 1330
					9000.053207	1 0,18 2
		WHITE / PLYWOOD / GREEN METAL	9500.053238	9000.053177	1 0,07 15 1330	
				9000.053191	1 0,18 2	
		CONCRETE MELAMINE / BLACK METAL	9500.054051	9000.054068	1 0,07 13 1330	
				9000.053207	1 0,18 2	
FOCUS			finishes	product code	package code	pack. m3 kg PLN qty
FOCUS		H 109 cm W 110 cm D 42 cm Kg 76 m3 0,18 pack.qty. 3	WHITE / OAK	9500.052606	9000.052606	1 0,05 24 3290
					9000.052613	1 0,07 23
					9000.052620	1 0,05 18
			WHITE / WALNUT	9500.054099	9000.052606	1 0,05 24 3290
					9003.054105	1 0,07 23
					9000.052620	1 0,05 18
		WHITE	9500.054112	9000.052606	1 0,05 24 3290	
				9000.054129	1 0,07 23	
				9000.052620	1 0,05 18	
HARBOUR			finishes	product code	package code	pack. m3 kg PLN qty
HARBOUR		H 75 cm W 120 cm D 60 cm Kg 23 m3 0,08 pack.qty. 2	WHITE / OAK	9500.052996	9003.053016	1 0,03 11 1400
					9000.053023	1 0,05 13
LIME			finishes	product code	package code	pack. m3 kg PLN qty
LIME		H 138 cm W 104 cm D 40 cm Kg 76 m3 0,13 pack.qty. 3	OAK / BLACK	9500.053276	9003.053283	1 0,06 28 3690
					9000.053290	1 0,03 15
					9003.053306	1 0,05 19
LOFT			finishes	product code	package code	pack. m3 kg PLN qty
LOFT		H 89 cm W 126 cm D 72 cm Kg 25 m3 0,06 pack.qty. 1	OAK / BLACK	9003.053481		0,06 25 2310

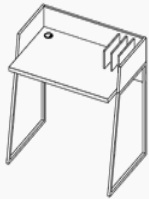

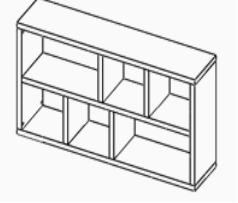
MAYA				finishes	product code	package code	pack. qty	m3	kg	PLN
MAYA		H 82 cm W 105 cm D 58 cm Kg 19 m3 0,05 pack.qty. 1		LIGHT OAK / BLACK	9003.054266			0,05	19	1750
				WALNUT / BLACK	9003.054273			0,05	19	1750
MITCH				finishes	product code	package code	pack. qty	m3	kg	PLN
MITCH		H 113 cm W 130 cm D 50 cm Kg 49 m3 0,10 pack.qty. 2		LIGHT OAK	9500.054457	9000.054471	1	0,06	33	1300
				MELAMINE / WHITE		9000.054464	1	0,03	17	
				LIGHT OAK	9500.054488	9000.054495	1	0,06	33	1300
				MELAMINE / BLACK		9000.054464	1	0,03	17	
MULTI				finishes	product code	package code	pack. qty	m3	kg	PLN
MULTI TRESTLES 160		H 77 cm W 160 cm D 90 cm Kg 22 m3 0,26 pack.qty. 2		WHITE / BLACK METAL	9500.613784	9000.619083	1	0,07	21	1920
						9000.053207	1	0,18	2	
				OAK / BLACK METAL	9500.613760	9003.612220	1	0,07	21	1920
						9000.053207	1	0,18	2	
				WALNUT / BLACK METAL	9500.613777	9003.619762	1	0,07	21	1920
						9000.053207	1	0,18	2	
				CONCRETE MELAMINE / BLACK METAL	9500.613982	9000.613968	1	0,07	19	1920
						9000.053207	1	0,18	2	
	WHITE / CHROME METAL	9500.611230	9000.619083	1	0,07	21	1920			
			9000.659096	1	0,16	2				
	OAK / CHROME METAL	9500.620836	9003.612220	1	0,07	21	1920			
			9000.659096	1	0,16	2				
	WALNUT / CHROME METAL	9500.611124	9003.619762	1	0,07	21	1920			
			9000.659096	1	0,16	2				
MULTI TRESTLES 180		H 77 cm W 180 cm D 90 cm Kg 24 m3 0,30 pack.qty. 2		WHITE / BLACK METAL	9500.613821	9000.611452	1	0,12	23	2040
						9000.053207	1	0,18	2	
				OAK / BLACK METAL	9500.613807	9003.612237	1	0,12	23	2040
						9000.053207	1	0,18	2	
				WALNUT / BLACK METAL	9500.613814	9003.619724	1	0,12	23	2040
						9000.053207	1	0,18	2	
	WHITE / CHROME METAL	9500.611452	9000.611452	1	0,12	23	2040			
			9000.659096	1	0,16	2				
	OAK / CHROME METAL	9500.621031	9003.612237	1	0,12	23	2040			
			9000.659096	1	0,16	2				
	WALNUT / CHROME METAL	9500.611360	9003.619724	1	0,12	23	2040			
			9000.659096	1	0,16	2				

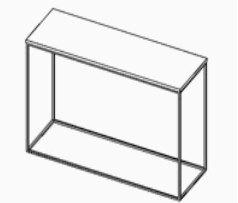

HOME OFFICE											
MULTI			finishes	product code	package code	pack. qty	m3	kg	PLN		
MULTI STORAGE 160		H 75 cm W 160 cm D 90 cm Kg 57 m3 0,24 pack.qty. 3	WHITE	9500.612305	9000.619083	1	0,07	21	3150		
					9000.612213	1	0,08	19			
					9000.612305	1	0,08	18			
					WALNUT / WHITE	9500.620171	9003.619762	1	0,07	21	3150
					9000.612213		1	0,08	19		
					9000.612305		1	0,08	18		
					OAK / WHITE	9500.620188	9003.612220	1	0,07	21	3150
					9000.612213		1	0,08	19		
					9000.612305		1	0,08	18		
MULTI STORAGE 180		H 75 cm W 180 cm D 90 cm Kg 59 m3 0,29 pack.qty. 3	WHITE	9500.620881	9000.611452	1	0,12	23	3270		
					9000.612213	1	0,08	19			
					9000.612305	1	0,08	18			
					WALNUT / WHITE	9500.620225	9003.619724	1	0,12	23	3270
					9000.612213		1	0,08	19		
					9000.612305		1	0,08	18		
					OAK / WHITE	9500.620232	9003.612237	1	0,12	23	3270
					9000.612213		1	0,08	19		
					9000.612305		1	0,08	18		
 PLY			finishes	product code	package code	pack. qty	m3	kg	PLN		
PLY		H 81 cm W 120 cm D 60 cm Kg 20 m3 0,09 pack.qty. 1	LIGHT OAK / BLACK METAL	9003.054082			0,09	16	1810		
PLY W/ DRAWER		H 81 cm W 120 cm D 60 cm Kg 24 m3 0,09 pack.qty. 1	LIGHT OAK / BLACK METAL	9003.053979			0,09	21	2290		
PRADO			finishes	product code	package code	pack. qty	m3	kg	PLN		
PRADO		H 75 cm W 130 cm D 60 cm Kg 46 m3 0,13 pack.qty. 3	WHITE / WHITE METAL	9500.052545	9000.052514	1	0,05	19	1780		
					9000.052521	1	0,05	25			
					9000.052545	1	0,03	3			
				WHITE / CHROME METAL	9500.052514	9000.052514	1	0,05	19	2070	
				9000.052521		1	0,05	25			
				9000.052538		1	0,03	3			

SPACE									
BRAND			finishes	product code	package code	pack. qty	m3	kg	PLN
SPACE		H 101 cm W 70 cm D 51 cm Kg 24 m3 0,13 pack.qty. 1	LIGHT OAK / WHITE METAL	9003.053719			0,13	25	2410
VOLGA									
			finishes	product code	package code	pack. qty	m3	kg	PLN
VOLGA		H 88 cm W 90 cm D 60 cm Kg 20 m3 0,06 pack.qty. 1	BLACK / OAK	9003.052965			0,06	20	1660
			BLACK / WALNUT	9003.052927			0,06	20	1660
			WHITE / WALNUT	9003.052958			0,06	20	1660
			WHITE / OAK	9003.052811			0,06	20	1660
			CONCRETE MELAMINE / BLACK	9000.054075			0,08	19	1660



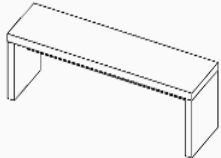

CONSOLES							
BERLIN			finishes	product code	package code	pack. qty	m3 kg PLN
BERLIN CONSOLE 150		H 83 cm W 150 cm D 34 cm Kg 35 m3 0,13 pack.qty. 1	WALNUT	9003.322570		1	0,13 36 1950
			OAK	9003.322563		1	0,13 37 1950
			WHITE	9000.322549		1	0,13 34 1560
			CONCRETE MELAMINE	9000.322587		1	0,13 37 1560
			WHITE / PLYWOOD	9000.322556		1	0,13 34 1560
GLEAM			finishes	product code	package code	pack. qty	m3 kg PLN
GLEAM CONSOLE 120		H 76 cm W 120 cm D 40 cm Kg 16 m3 0,41 pack.qty. 2	OXIDE / BLACK METAL	9500.628894	9000.626531	1	0,02 7 1610
					9000.628856	1	0,39 9
			OAK / BLACK METAL	9500.628870	9003.626555	1	0,02 7 1700
					9000.628856	1	0,39 9
			WALNUT / BLACK METAL	9500.628863	9003.628771	1	0,02 7 1700
					9000.628856	1	0,39 9
			OAK / CHROME METAL	9500.629471	9003.626555	1	0,02 7 2200
		9000.629754	1	0,39 9			
GLEAM CONSOLE 120 KIT		H 76 cm W 120 cm D 40 cm Kg 11 m3 0,08 pack.qty. 1	OXIDE / BLACK METAL	9000.630491		1	0,08 12 1550
			OAK / BLACK METAL	9003.630453		1	0,08 12 1620
			WALNUT / BLACK METAL	9003.630477		1	0,08 12 1620
			OAK / CHROME METAL	9003.630460		1	0,08 12 2080
			WALNUT / CHROME METAL	9003.630484		1	0,08 12 2080
GLEAM CONSOLE 120 MARBLE		H 76 cm W 120 cm D 40 cm Kg 41 m3 0,49 pack.qty. 2	WHITE MARBLE / BLACK METAL	9500.628924	9000.627279	1	0,10 32 3210
					9000.628856	1	0,39 9
			BLACK MARBLE / BLACK METAL	9500.628900	9000.627286	1	0,10 32 3210
					9000.628856	1	0,39 9
			GREEN MARBLE / BLACK METAL	9500.628917	9000.627293	1	0,10 32 3210
					9000.628856	1	0,39 9
			WHITE MARBLE / CHROME METAL	9500.629495	9000.627279	1	0,10 32 3710
					9000.629754	1	0,39 9
		9500.629501	9000.627286	1	0,10 32 3710		
		9000.629754	1	0,39 9			
		9500.629518	9000.627293	1	0,10 32 3710		
		9000.629754	1	0,39 9			



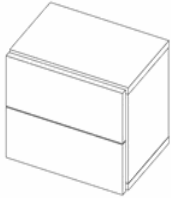
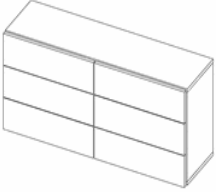
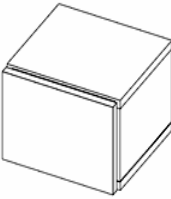
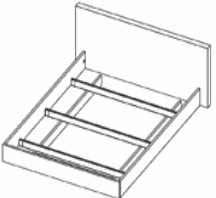

CONSOLES





GLEAM			finishes	product code	package code	pack. qty	m3	kg	PLN
GLEAM CONSOLE 120 MARBLE KIT		H 76 cm W 120 cm D 40 cm Kg 37 m3 0,16 pack.qty. 2	WHITE MARBLE / BLACK METAL	9500.630248	9000.627279	1	0,10	32	3070
					9000.630040	1	0,06	5	
			BLACK MARBLE / BLACK METAL	9500.630262	9000.627286	1	0,10	32	3070
					9000.630040	1	0,06	5	
			GREEN MARBLE / BLACK METAL	9500.630286	9000.627293	1	0,10	32	3070
					9000.630040	1	0,06	5	
			GREEN MARBLE / CHROME METAL	9500.630293	9000.627293	1	0,10	32	3540
		9000.630057	1	0,06	5				
		WHITE MARBLE / CHROME METAL	9500.630255	9000.627279	1	0,10	32	3540	
				9000.630057	1	0,06	5		
		BLACK MARBLE / CHROME METAL	9500.630279	9000.627286	1	0,10	32	3540	
				9000.630057	1	0,06	5		
HELIX			finishes	product code	package code	pack. qty	m3	kg	PLN
HELIX CONSOLE 120 MARBLE		H 76 cm W 120 cm D 40 cm Kg 41 m3 0,31 pack.qty. 2	WHITE MARBLE / BLACK METAL	9500.627460	9000.627279	1	0,10	32	3210
					9000.626807	1	0,21	9	
			BLACK MARBLE / BLACK METAL	9500.627477	9000.627286	1	0,10	32	3210
				9000.626807	1	0,21	9		
		GREEN MARBLE / BLACK METAL	9500.627484	9000.627293	1	0,10	32	3210	
				9000.626807	1	0,21	9		

SEATING						
DETROIT			finishes	product code	package code	pack. m3 kg PLN qty
DETROIT BENCH 140		H 43 cm W 140 cm D 38 cm Kg 15 m3 0,10 pack.qty. 1	CONCRETE MELAMINE / BLACK	9000.130663		0,10 16 690
SALLY			finishes	product code	package code	pack. m3 kg PLN qty
SALLY CHAIRS (2)		H 87 cm W 51 cm D 49 cm Kg 12 m3 0,33 pack.qty. 1	OAK	SALY.130700		0,33 12 2200
set of 2 chairs / delivered assembled						

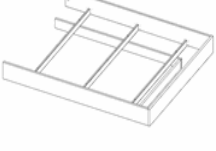

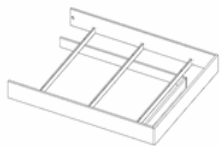
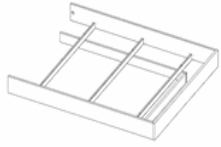

BEDROOMS

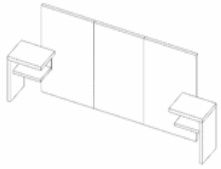
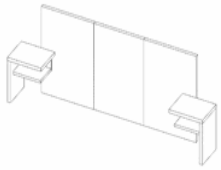
AURORA			finishes	product code	package code	pack. qty	m3	kg	PLN
AURORA NIGHT TABLE WITH 2 DRAWERS		H 45 cm W 60 cm D 44 cm Kg 0 m3 0,15 pack.qty. 2	WALNUT	9500.758492	9003.758492	1	0,06	16	1700
					9003.758614	1	0,09	10	
			WHITE	9500.310263	9000.310263	1	0,06	15	1700
					9000.758621	1	0,09	10	
AURORA CHEST OF 6 DRAWERS		H 82 cm W 180 cm D 53 cm Kg 123 m3 0,96 pack.qty. 5	WALNUT	9500.758515	9003.758508	1	0,10	23	5830
					9003.758515	1	0,07	20	
					9003.758522	1	0,07	22	
					9003.756467	2	0,36	29	
			WHITE	9500.758256	9000.758232	1	0,10	23	5830
					9000.758249	1	0,07	20	
		9000.758256	1	0,07	22				
		9000.758669	2	0,36	29				
FLOAT			finishes	product code	package code	pack. qty	m3	kg	PLN
FLOAT NIGHT TABLE 1 DRAWER		H 31 cm W 45 cm D 43 cm Kg 12 m3 0,04 pack.qty. 1	WALNUT	9003.759543			0,04	13	1280
			WHITE	9000.759642			0,04	12	1010
FLOAT BED 150		H 31/81 cm W 180 cm D 216 cm Kg 58 m3 0,21 pack.qty. 2	WALNUT	9500.758478					3960
FLOAT BED 160		H 31/81 cm W 180 cm D 208 cm Kg 58 m3 0,20 pack.qty. 2	WALNUT	9500.757556					3960
			WHITE	9500.759406					3960
FLOAT BED 180		H 31/81 cm W 200 cm D 208 cm Kg 61 m3 0,26 pack.qty. 3	WALNUT	9500.758720					4130
			WHITE	9500.758799					4130
FLOAT BED 150 W/ SLATS		H 31/81 cm W 180 cm D 216 cm Kg 75 m3 0,35 pack.qty. 3	WALNUT	9500.758522					4870



BEDROOMS						
FLOAT			finishes	product code	package code	pack. m3 kg PLN qty
FLOAT BED 160 W/ SLATS		H 31/81 cm W 180 cm D 208 cm Kg 77 m3 0,36 pack.qty. 3	WALNUT	9500.758843		4870
			WHITE	9500.758881		4870
FLOAT BED 180 W/ SLATS		H 31/81 cm W 200 cm D 208 cm Kg 84 m3 0,44 pack.qty. 4	WALNUT	9500.759673		5080
			WHITE	9500.759680		5080
FLOAT HEADBOARD 150		H 70 cm W 180 cm D 8 cm Kg 20 m3 0,13 pack.qty. 1	WALNUT	9003.758478		0,13 20 1740
			mattress dimensions : 153x204 cm			
HEADBOARD 160		H 70 cm W 180 cm D 8 cm Kg 20 m3 0,12 pack.qty. 1	WALNUT	9003.757549		0,12 20 1740
			WHITE	9000.759406		0,12 20 1740
mattress dimensions : 160x200 cm						
FLOAT HEADBOARD 180		H 70 cm W 200 cm D 8 cm Kg 22 m3 0,16 pack.qty. 1	WALNUT	9003.758720		0,16 22 1820
			WHITE	9000.759413		0,16 22 1820
mattress dimensions : 180x200 cm						
FLOAT STRUCTURE 150		H 31 cm W 159 cm D 207 cm Kg 37 m3 0,08 pack.qty. 1	WALNUT	9003.758485		0,08 38 2220
			mattress dimensions : 153x204 cm			

FLOAT		finishes	product code	package code	pack. qty	m3	kg	PLN	
FLOAT STRUCTURE 160		H 31 cm W 167 cm D 203 cm Kg 41 m3 0,08 pack.qty. 1	WHITE	9000.758355		0,08	37	2220	
			WALNUT	9003.757556		0,08	38	2220	
		mattress dimensions : 160x200 cm							
FLOAT STRUCTURE 180		H 31 cm W 186 cm D 203 cm Kg 39 m3 0,11 pack.qty. 2	WHITE	9500.758263				2310	
			WALNUT	9500.758744				2310	
		mattress dimensions : 180x200 cm							
FLOAT MATTRESS SUPPORT 150		H 3 cm W 154 cm D 204 cm Kg 17 m3 0,14 pack.qty. 1	METAL / WOOD	9000.279164		0,14	18	910	
FLOAT MATTRESS SUPPORT 160		H 3 cm W 160 cm D 200 cm Kg 19 m3 0,16 pack.qty. 1	METAL / WOOD	9000.279140		0,16	20	910	
FLOAT MATTRESS SUPPORT 180		H 3 cm W 180 cm D 200 cm Kg 22 m3 0,18 pack.qty. 1	METAL / WOOD	9000.279157		0,18	22	950	
	HUGO		finishes	product code	package code	pack. qty	m3	kg	PLN
HUGO HEADBOARD 160		H 100 cm W 261 cm D 39 cm Kg 47 m3 0,16 pack.qty. 3	LIGHT OAK	9500.764295	9000.764264	1	0,05	17	2200
			MELAMINE / WHITE		9000.764271	1	0,07	21	
					9000.764301	1	0,04	9	
			LIGHT OAK	9500.764257	9000.764264	1	0,05	17	2260
		MELAMINE / ANTHRACITE		9000.764271	1	0,07	21		
				9000.764288	1	0,04	9		
HUGO HEADBOARD 180		H 100 cm W 281 cm D 39 cm Kg 49 m3 0,17 pack.qty. 3	LIGHT OAK	9500.764332	9000.764264	1	0,05	17	2270
			MELAMINE / WHITE		9000.764271	1	0,07	21	
					9000.764349	1	0,05	11	
			LIGHT OAK	9500.764318	9000.764264	1	0,05	17	2380
		MELAMINE / ANTHRACITE		9000.764271	1	0,07	21		
				9000.764325	1	0,05	11		

CHEST OF DRAWERS

 HUGO		finishes	product code	package code	pack. qty	m3	kg	PLN	
HUGO CHEST OF 5 DRAWERS 	H 113 cm W 63 cm D 50 cm Kg 54 m3 0,16 pack.qty. 2	LIGHT OAK	9500.764394	9000.764400	1	0,09	29	3350	
		MELAMINE		9000.764417	1	0,07	25		
HUGO CHEST OF 5 DRAWERS W/ DOOR 	H 113 cm W 113 cm D 50 cm Kg 84 m3 0,21 pack.qty. 3	LIGHT OAK	9500.764479	9000.764455	1	0,09	32	4290	
		MELAMINE / WHITE		9000.764417	1	0,07	25		
						9000.764486	1	0,05	27
		LIGHT OAK	9500.764448	9000.764455	1	0,09	32	4340	
MELAMINE / ANTHRACITE		9000.764417	1	0,07	25				
				9000.764462	1	0,05	27		
HUGO CHEST OF 5 DRAWERS W/ HANGER 	H 113 cm W 63 cm D 50 cm Kg 60 m3 0,16 pack.qty. 2	LIGHT OAK	9500.764424	9000.764431	1	0,09	35	3990	
		MELAMINE		9000.764417	1	0,07	25		

VANITY TABLES

 HUGO		finishes	product code	package code	pack. qty	m3	kg	PLN
HUGO VANITY TABLE		H 139 cm W 105 cm D 42 cm	LIGHT OAK MELAMINE / ANTHRACITE	9000.980015		0,09	30	1780
		Kg 28 m3 0,09 pack.qty. 1	LIGHT OAK MELAMINE / WHITE	9000.980022		0,09	31	1680

Conditions

Valid: from: 01/01/2023 to: 31/12/2023

Lead Time: 4-6 weeks

*** TemaHome reserves the right to change the information contained in this pricelist without any further notice.**

Claims Policy

All transport claims must be submitted in writing, within 5 working days of receipt of merchandise.

If the shipment is not delivered in accordance with the quantity, cartons, and number of packages shown on the bill of lading or the merchandise is freight damaged, do not accept the shipment until such shortages or damages are noted on the freight bill.

If you believe the merchandise is damaged due to freight handling, set it aside in its original packaging and contact our Customer Service Department.

Do not deduct for damaged and/or missing items. Do not discard damaged items without authorization.

All other claims should be sent in writing and as detailed as possible. A photograph of the damaged area of the product will be required.

Prior to the return of goods, the written claim must be submitted and authorized.

Automatic deductions on invoices are not accepted without prior authorization.

All claims will be reviewed and answered within 5 to 10 working days of the date of receipt.

Before making a claim, please ensure that one the following situations is not present:

Your customer is carefully following the assembly instructions. We will not replace components that are damaged as a result of bad mounting.

If your customer is claiming that the wood is darkening in certain spots or as a whole, please explain that the darkening of any wood product is a result of its exposure to daylight or sunlight (wood is a living material).

General Product Information

Product components consist in straight panels which are made up of the following raw materials:

- chipboard
 - Medium Density Fiberboard (MDF or fiber board)
 - honeycomb
 - veneer (cherry, oak*, beech* and walnut)
 - glue
 - varnish or paint
- * chocolate color is stained on oak veneer and wenge color is stained on beech veneer.

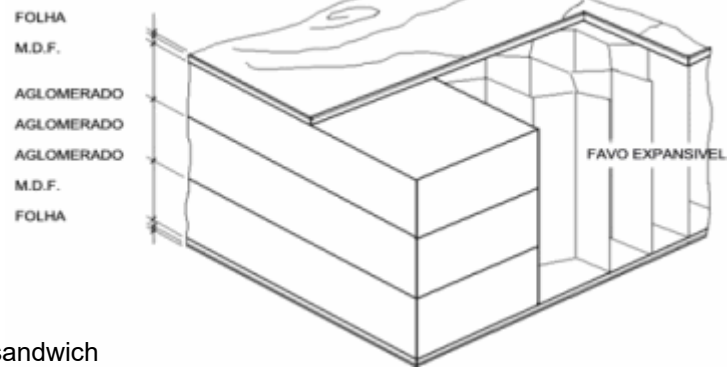

All 1.6 cm thick components are made of regular chipboard or particle board. Thicker components are made of sandwich construction with a solid chipboard frame. Additional cross bars are used for larger elements. The honeycomb inlay provides stability and strength to the products. The panels are then varnished or lacquered depending on the piece.

Wood is a living material and as such suffers changes caused by the environment. Sunlight and, especially, ultra violet light accelerate the darkening or lightening of wood depending on the veneer. This phenomenon is most evident in light woods. We recommend that during the first days of exposure to light, the objects placed on the furniture are moved around frequently to allow for the darkening/ lightening of wood to be even without causing lighter and darker spots.

TemaHome products are intended solely for residential use and are unsuitable for intensive use such as in restaurants, bars, etc.

Our varnish offers ISO standard resistance for household use.

Like other veneered / wooden products, our products are sensible to liquids. Normal resistance is a few minutes but if water is left on the furniture for a long period of time it will result in the absorption and expansion of the agglomerate.

The products are sensitive to high temperatures. Hot plates taken directly out of the oven can not be placed directly on the surface.

For the maintenance of the surfaces, normal furniture cleaning products that are non abrasive should be used. Clean with a damp cloth and avoid solvents.

TEMAHOME PORTUGAL S.A.
Factory - Tomar
Zona Industrial Tomar
2305 - 127 Tomar
Portugal

Tel.: (+351) 249 380 020
Fax: (+351) 249 380 029

TEMAHOME GROUP
Annecy - France
Tomar & Lisboa - Portugal
Wilmington, DE -USA

COPYRIGHT 2022 TEMAHOME
ALL RIGHTS RESERVED
Temahome reserves the right
to change any information in
this catalogue, including but
not limited to, discounting and/
or altering products, at any
time and without giving prior
notice.

Temahome is not responsible
for typographical or printing
errors.