

Expand
Your
Living Space

INNOVATION LIVING™



Cennik detaliczny ważny od 01.08.2022 – ver. 5
Ceny detaliczne brutto, PLN.

INDEX





MODULAR	SPLITBACK DUBLEXO OLDSCHOOL	4-8
COMPACT	CUBED 90, 140, 160 COSIAL 80, 140, 160 OLAN VITHUS EIVOR SPRING 140, 160 EIVOR DUAL 140, 160 KILLIAN SPRING 140, 160 KILLIAN DUAL 140, 160	9-12
UNIQUE	LONG HORN DELUXE EXCESS LOUNGER UNFURL UNFURL LOUNGER	13
DAYBEDS	GHIA ROLLO BOW ROLLO STYLETTO ROLLO STEM PURI VANADIS ZEAL SIGMUND	14-15
SLYDERS	CONLIX ACHILLAS REVIVUS MERGA PASCALA RECAST SLY SLY WOOD FRODE NARVI TRYM IDUN ELUMA DELUXE BUTTON YONATA SALLA NORDHAM MALLOY MALLOY WOOD BIFROST D.E.L. SUPREMAX D.E.L. CASSIUS D.E.L. PYXIS D.E.L. BRAGI VOGAN VOGAN LOUNGER OSVALD TRIPPI CORNILA	16-21
MULTIFUNCTIONALS - DESIGN IT YOURSELF	SOFA BED FRAMES, MATTRESSES & COVERS	22-26
ACCESSORIES	CUSHIONS & CUSHION COVERS FLIP HEAD REST PAUKE TRIANGULAR ACCORDION BEAN BAGS VIKKO CHAIRS MATTRESS PADS TRAYS TABELS FABRICS	27-31

MODULAR

NR.ART.	OPIS	TYGODNIE	M3	CLL.	TKANINA	CENA
---------	------	----------	----	------	---------	------

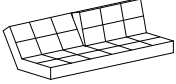
MODULAR

SPLITBACK SOFA

	741010XXX	SPLITBACK SOFA - CZĘŚĆ TAPICEROWANA, 115-210	15-17	0,4839	1	DESS. XXX	5490
	741010216	SPLITBACK SOFA - CZĘŚĆ TAPICEROWANA, 115-210	4-6	0,4839	1	DESS. 216	4670
	741010507	SPLITBACK SOFA - CZĘŚĆ TAPICEROWANA, 115-210	4-6	0,4839	1	DESS. 507	4670
	741010521	SPLITBACK SOFA - CZĘŚĆ TAPICEROWANA, 115-210	4-6	0,4839	1	DESS. 521	4670
	741010525	SPLITBACK SOFA - CZĘŚĆ TAPICEROWANA, 115-210	4-6	0,4839	1	DESS. 525	4670
	741010531	SPLITBACK SOFA - CZĘŚĆ TAPICEROWANA, 115-210	4-6	0,4839	1	DESS. 531	4670
	741010580	SPLITBACK SOFA - CZĘŚĆ TAPICEROWANA, 115-210	4-6	0,4839	1	DESS. 580	4670
	741010-0-2	SP NOGI DO SOFY, CHROM/CZARNY MAT	4-6	0,0223	1		920
	741007-10-1-2	SP STYLETTO HL NOGI DO SOFY, JASNE DREWNO/CZARNY MAT	4-6	0,0212	2		920
	741007-10-3-2	SP STYLETTO HL NOGI DO SOFY, CIEMNE DREWNO/CZARNY MAT	4-6	0,0212	2		920
	741007-10-4-2	SP STYLETTO HL NOGI DO SOFY, CZARNE DREWNO/CZARNY MAT	4-6	0,0212	2		920
	741007-11-1-2	SP STEM HL NOGI DO SOFY, JASNE DREWNO/CZARNY MAT	4-6	0,0218	2		920
	741043000-5-2	SP EIK NOGI DO SOFY, DĄB NATURALNY/CZARNY MAT	4-6	0,0366	2		1830
	741043000-7-2	SP EIK NOGI DO SOFY, DĄB BARWIONY „SMOKED”/CZARNY MAT	4-6	0,0366	2		1830

SPLITBACK FOTEL

	741011XXX	SPLITBACK FOTEL - CZĘŚĆ TAPICEROWANA, 115-90	15-17	0,2189	1	DESS. XXX	2570
	741011216	SPLITBACK FOTEL - CZĘŚĆ TAPICEROWANA, 115-90	4-6	0,2189	1	DESS. 216	2220
	741011507	SPLITBACK FOTEL - CZĘŚĆ TAPICEROWANA, 115-90	4-6	0,2189	1	DESS. 507	2220
	741011521	SPLITBACK FOTEL - CZĘŚĆ TAPICEROWANA, 115-90	4-6	0,2189	1	DESS. 521	2220
	741011525	SPLITBACK FOTEL - CZĘŚĆ TAPICEROWANA, 115-90	4-6	0,2189	1	DESS. 525	2220
	741011531	SPLITBACK FOTEL - CZĘŚĆ TAPICEROWANA, 115-90	4-6	0,2189	1	DESS. 531	2220
	741011580	SPLITBACK FOTEL - CZĘŚĆ TAPICEROWANA, 115-90	4-6	0,2189	1	DESS. 580	2220
	741011-0-2	SP NOGI DO FOTELE, CHROM/CZARNY MAT	4-6	0,0100	1		790
	741009-10-1-2	SP STYLETTO HL NOGI DO F. JASNE DREWNO/CZARNY MAT	4-6	0,0133	2		790
	741009-10-3-2	SP STYLETTO HL NOGI DO F. CIEMNE DREWNO/CZARNY MAT	4-6	0,0133	2		790
	741009-10-4-2	SP STYLETTO HL NOGI DO F. CZARNE DREWNO/CZARNY MAT	4-6	0,0133	2		790
	741009-11-1-2	SP STEM HL NOGI DO FOTELE, JASNE DREWNO/CZARNY MAT	4-6	0,0139	2		790
	741044000-5-2	SP EIK NOGI DO FOTELE, DĄB NATURALNY/CZARNY MAT	4-6	0,0238	2		1770
	741044000-7-2	SP EIK NOGI DO FOTELE, DĄB BARWIONY „SMOKED”/CZARNY MAT	4-6	0,0238	2		1770

MODULAR



	NR.ART.	OPIS	TYGODNIE	M3	CLL.	TKANINA	CENA
--	---------	------	----------	----	------	---------	------

MODULAR

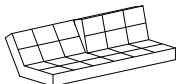
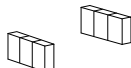
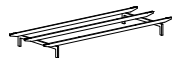
SPLITBACK SOFA Z PODŁOKIETNIKAMI TAPICEROWANYMI

	741010XXX	SPLITBACK SOFA - CZĘŚĆ TAPICEROWANA, 115-210	15-17	0,4839	1	DESS. XXX	5490
	741010216	SPLITBACK SOFA - CZĘŚĆ TAPICEROWANA, 115-210	4-6	0,4839	1	DESS. 216	4670
	741010507	SPLITBACK SOFA - CZĘŚĆ TAPICEROWANA, 115-210	4-6	0,4839	1	DESS. 507	4670
	741010521	SPLITBACK SOFA - CZĘŚĆ TAPICEROWANA, 115-210	4-6	0,4839	1	DESS. 521	4670
	741010525	SPLITBACK SOFA - CZĘŚĆ TAPICEROWANA, 115-210	4-6	0,4839	1	DESS. 525	4670
	741010531	SPLITBACK SOFA - CZĘŚĆ TAPICEROWANA, 115-210	4-6	0,4839	1	DESS. 531	4670
	741010580	SPLITBACK SOFA - CZĘŚĆ TAPICEROWANA, 115-210	4-6	0,4839	1	DESS. 580	4670
	741010020XXX	SP SOFA - SHARP PODŁOKIETNIKI, 1 SET	15-17	0,1306	1	DESS. XXX	1450
	741010020216	SP SOFA - SHARP PODŁOKIETNIKI, 1 SET	4-6	0,1306	1	DESS. 216	1220
	741010020507	SP SOFA - SHARP PODŁOKIETNIKI, 1 SET	4-6	0,1306	1	DESS. 507	1220
	741010020521	SP SOFA - SHARP PODŁOKIETNIKI, 1 SET	4-6	0,1306	1	DESS. 521	1220
	741010020525	SP SOFA - SHARP PODŁOKIETNIKI, 1 SET	4-6	0,1306	1	DESS. 525	1220
	741010020531	SP SOFA - SHARP PODŁOKIETNIKI, 1 SET	4-6	0,1306	1	DESS. 531	1220
	741010020580	SP SOFA - SHARP PODŁOKIETNIKI, 1 SET	4-6	0,1306	1	DESS. 580	1220
	741010020-0-2	SP NOGI DO SOFY Z PODŁOKIETNIKAMI, CHROM/CZARNY MAT	4-6	0,0272	1		1030
	741007020-10-1-2	SP STYLETTO HL NOGI DO S. Z PODŁ., JASNE DREWNO/CZARNY	4-6	0,0228	2		1030
	741007020-10-3-2	SP STYLETTO HL NOGI DO S. Z PODŁ., CIEMNE DREWNO/CZARNY	4-6	0,0228	2		1030
	741007020-10-4-2	SP STYLETTO HL NOGI DO S. Z PODŁ., CZARNE DREWNO/CZARNY	4-6	0,0228	2		1030
	741007020-11-1-2	SP STEM HL NOGI DO S. Z PODŁ. JASNE DREWNO/CZARNY	4-6	0,0234	2		1030

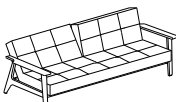
SPLITBACK SOFA Z PODŁOKIETNIKAMI FREJ

	95-74101027XXX-5-2	SPLITBACK SOFA, PODŁOKIETNIKI FREJ DĄB NATURALNY, 115-210	15-17	0,6169	3	DESS. XXX	8330
	95-74101027216-5-2	SPLITBACK SOFA, PODŁOKIETNIKI FREJ DĄB NATURALNY, 115-210	4-6	0,6169	3	DESS. 216	7510
	95-74101027507-5-2	SPLITBACK SOFA, PODŁOKIETNIKI FREJ DĄB NATURALNY, 115-210	4-6	0,6169	3	DESS. 507	7510
	95-74101027521-5-2	SPLITBACK SOFA, PODŁOKIETNIKI FREJ DĄB NATURALNY, 115-210	4-6	0,6169	3	DESS. 521	7510
	95-74101027525-5-2	SPLITBACK SOFA, PODŁOKIETNIKI FREJ DĄB NATURALNY, 115-210	4-6	0,6169	3	DESS. 525	7510
	95-74101027531-5-2	SPLITBACK SOFA, PODŁOKIETNIKI FREJ DĄB NATURALNY, 115-210	4-6	0,6169	3	DESS. 531	7510
	95-74101027580-5-2	SPLITBACK SOFA, PODŁOKIETNIKI FREJ DĄB NATURALNY, 115-210	4-6	0,6169	3	DESS. 580	7510
	95-74101027XXX-7-2	SPLITBACK SOFA, PODŁOK. FREJ DĄB BARW. „SMOKED”, 115-210	15-17	0,6169	3	DESS. XXX	8330
	95-74101027216-7-2	SPLITBACK SOFA, PODŁOK. FREJ DĄB BARW. „SMOKED”, 115-210	4-6	0,6169	3	DESS. 216	7510
	95-74101027507-7-2	SPLITBACK SOFA, PODŁOK. FREJ DĄB BARW. „SMOKED”, 115-210	4-6	0,6169	3	DESS. 507	7510
	95-74101027521-7-2	SPLITBACK SOFA, PODŁOK. FREJ DĄB BARW. „SMOKED”, 115-210	4-6	0,6169	3	DESS. 521	7510
	95-74101027525-7-2	SPLITBACK SOFA, PODŁOK. FREJ DĄB BARW. „SMOKED”, 115-210	4-6	0,6169	3	DESS. 525	7510
	95-74101027531-7-2	SPLITBACK SOFA, PODŁOK. FREJ DĄB BARW. „SMOKED”, 115-210	4-6	0,6169	3	DESS. 531	7510
	95-74101027580-7-2	SPLITBACK SOFA, PODŁOK. FREJ DĄB BARW. „SMOKED”, 115-210	4-6	0,6169	3	DESS. 580	7510

SPLITBACK FOTEL Z PODŁOKIETNIKAMI FREJ

	95-74101126XXX-5-2	SPLITBACK FOTEL, PODŁOKIETNIKI FREJ DĄB NATURALNY, 115-90	15-17	0,3429	3	DESS. XXX	5370
	95-74101126216-5-2	SPLITBACK FOTEL, PODŁOKIETNIKI FREJ DĄB NATURALNY, 115-90	4-6	0,3429	3	DESS. 216	5020
	95-74101126507-5-2	SPLITBACK FOTEL, PODŁOKIETNIKI FREJ DĄB NATURALNY, 115-90	4-6	0,3429	3	DESS. 507	5020
	95-74101126521-5-2	SPLITBACK FOTEL, PODŁOKIETNIKI FREJ DĄB NATURALNY, 115-90	4-6	0,3429	3	DESS. 521	5020
	95-74101126525-5-2	SPLITBACK FOTEL, PODŁOKIETNIKI FREJ DĄB NATURALNY, 115-90	4-6	0,3429	3	DESS. 525	5020
	95-74101126531-5-2	SPLITBACK FOTEL, PODŁOKIETNIKI FREJ DĄB NATURALNY, 115-90	4-6	0,3429	3	DESS. 531	5020
	95-74101126580-5-2	SPLITBACK FOTEL, PODŁOKIETNIKI FREJ DĄB NATURALNY, 115-90	4-6	0,3429	3	DESS. 580	5020
	95-74101126XXX-7-2	SPLITBACK FOTEL, PODŁOK. FREJ DĄB BARW. „SMOKED”, 115-90	15-17	0,3429	3	DESS. XXX	5370
	95-74101126216-7-2	SPLITBACK FOTEL, PODŁOK. FREJ DĄB BARW. „SMOKED”, 115-90	4-6	0,3429	3	DESS. 216	5020
	95-74101126507-7-2	SPLITBACK FOTEL, PODŁOK. FREJ DĄB BARW. „SMOKED”, 115-90	4-6	0,3429	3	DESS. 507	5020
	95-74101126521-7-2	SPLITBACK FOTEL, PODŁOK. FREJ DĄB BARW. „SMOKED”, 115-90	4-6	0,3429	3	DESS. 521	5020
	95-74101126525-7-2	SPLITBACK FOTEL, PODŁOK. FREJ DĄB BARW. „SMOKED”, 115-90	4-6	0,3429	3	DESS. 525	5020
	95-74101126531-7-2	SPLITBACK FOTEL, PODŁOK. FREJ DĄB BARW. „SMOKED”, 115-90	4-6	0,3429	3	DESS. 531	5020
	95-74101126580-7-2	SPLITBACK FOTEL, PODŁOK. FREJ DĄB BARW. „SMOKED”, 115-90	4-6	0,3429	3	DESS. 580	5020

MODULAR

NR.ART.	OPIS	TYGODNIE	M3	CLL.	TKANINA	CENA
---------	------	----------	----	------	---------	------

MODULAR





SPLITBACK SOFA Z PODŁOKIETNIKAMI LAUGE

	95-74101057XXX-3-2	SPLITBACK SOFA, NOGI/PODŁOKIETNIKI LAUGE ORZECH, 115-210	15-17	0,5807	3	DESS. XXX	
	95-74101057216-3-2	SPLITBACK SOFA, NOGI/PODŁOKIETNIKI LAUGE ORZECH, 115-210	4-6	0,5807	3	DESS. 216	7120
	95-74101057507-3-2	SPLITBACK SOFA, NOGI/PODŁOKIETNIKI LAUGE ORZECH, 115-210	4-6	0,5807	3	DESS. 507	7120
	95-74101057521-3-2	SPLITBACK SOFA, NOGI/PODŁOKIETNIKI LAUGE ORZECH, 115-210	4-6	0,5807	3	DESS. 521	7120
	95-74101057525-3-2	SPLITBACK SOFA, NOGI/PODŁOKIETNIKI LAUGE ORZECH, 115-210	4-6	0,5807	3	DESS. 525	7120
	95-74101057531-3-2	SPLITBACK SOFA, NOGI/PODŁOKIETNIKI LAUGE ORZECH, 115-210	4-6	0,5807	3	DESS. 531	7120
	95-74101057580-3-2	SPLITBACK SOFA, NOGI/PODŁOKIETNIKI LAUGE ORZECH, 115-210	4-6	0,5807	3	DESS. 580	7120



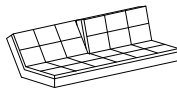

SPLITBACK FOTEL Z NOGAMI LAUGE

	95-74101156XXX-2	SPLITBACK FOTEL, NOGI LAUGE CZARNY MAT, 115-90	15-17	0,2390	2	DESS. XXX	3590
	95-74101156216-2	SPLITBACK FOTEL, NOGI LAUGE CZARNY MAT, 115-90	4-6	0,2390	2	DESS. 216	3240
	95-74101156507-2	SPLITBACK FOTEL, NOGI LAUGE CZARNY MAT, 115-90	4-6	0,2390	2	DESS. 507	3240
	95-74101156521-2	SPLITBACK FOTEL, NOGI LAUGE CZARNY MAT, 115-90	4-6	0,2390	2	DESS. 521	3240
	95-74101156525-2	SPLITBACK FOTEL, NOGI LAUGE CZARNY MAT, 115-90	4-6	0,2390	2	DESS. 525	3240
	95-74101156531-2	SPLITBACK FOTEL, NOGI LAUGE CZARNY MAT, 115-90	4-6	0,2390	2	DESS. 531	3240
	95-74101156580-2	SPLITBACK FOTEL, NOGI LAUGE CZARNY MAT, 115-90	4-6	0,2390	2	DESS. 580	3240

DUBLEXO SOFA

	741050XXX	DUBLEXO SOFA - CZĘŚĆ TAPICEROWANA, 115-210	15-17	0,5885	1	DESS. XXX	5940
	741050527	DUBLEXO SOFA - CZĘŚĆ TAPICEROWANA, 115-210	4-6	0,5885	1	DESS. 527	5220
	741050558	DUBLEXO SOFA - CZĘŚĆ TAPICEROWANA, 115-210	4-6	0,5885	1	DESS. 558	5220
	741050563	DUBLEXO SOFA - CZĘŚĆ TAPICEROWANA, 115-210	4-6	0,5885	1	DESS. 563	5220
	741010-0-2	SP NOGI DO SOFY, CHROM/CZARNY MAT	4-6	0,0223	1		920
		741007-10-1-2	SP STYLETTO HL NOGI DO SOFY, JASNE DREWNO/CZARNY MAT	4-6	0,0212	2	
741007-10-3-2		SP STYLETTO HL NOGI DO SOFY, CIEMNE DREWNO/CZARNY MAT	4-6	0,0212	2		920
741007-10-4-2		SP STYLETTO HL NOGI DO SOFY, CZARNE DREWNO/CZARNY MAT	4-6	0,0212	2		920
	741007-11-1-2	SP STEM HL NOGI DO SOFY, JASNE DREWNO/CZARNY MAT	4-6	0,0218	2		920
		741043000-5-2	SP EIK NOGI DO SOFY, DĄB NATURALNY/CZARNY MAT	4-6	0,0366	2	
741043000-7-2		SP EIK NOGI DO SOFY, DĄB BARWIONY „SMOKED”/CZARNY MAT	4-6	0,0366	2		1830

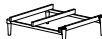
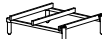
DUBLEXO FOTEL

	741051XXX	DUBLEXO FOTEL - CZĘŚĆ TAPICEROWANA, 115-90	15-17	0,2650	1	DESS. XXX	3060
	741051527	DUBLEXO FOTEL - CZĘŚĆ TAPICEROWANA, 115-90	4-6	0,2650	1	DESS. 527	2650
	741051558	DUBLEXO FOTEL - CZĘŚĆ TAPICEROWANA, 115-90	4-6	0,2650	1	DESS. 558	2650
	741051563	DUBLEXO FOTEL - CZĘŚĆ TAPICEROWANA, 115-90	4-6	0,2650	1	DESS. 563	2650
	741011-0-2	SP NOGI DO FOTELE, CHROM/CZARNY MAT	4-6	0,0100	1		790
		741009-10-1-2	SP STYLETTO HL NOGI DO FOT., JASNE DREWNO/CZARNY MAT	4-6	0,0133	2	
741009-10-3-2		SP STYLETTO HL NOGI DO FOT., CIEMNE DREWNO/CZARNY MAT	4-6	0,0133	2		790
741009-10-4-2		SP STYLETTO HL NOGI DO FOT., CZARNE DREWNO/CZARNY MAT	4-6	0,0133	2		790
	741009-11-1-2	SP STEM HL NOGI DO FOTELE, JASNE DREWNO/CZARNY MAT	4-6	0,0139	2		790
		741044000-5-2	SP EIK NOGI DO FOTELE, DĄB NATURALNY/CZARNY MAT	4-6	0,0238	2	
741044000-7-2		SP EIK NOGI DO FOTELE, DĄB BARWIONY „SMOKED”/CZARNY MAT	4-6	0,0238	2		1770

MODULAR

NR.ART.	OPIS	TYGODNIE	M3	CLL.	TKANINA	CENA
---------	------	----------	----	------	---------	------

MODULAR

DUBLEXO SOFA Z PODŁOKIETNIKAMI TAPICEROWANYMI

	741050XXX	DUBLEXO SOFA - CZĘŚĆ TAPICEROWANA, 115-210	15-17	0,5885	1	DESS. XXX	5940
	741050527	DUBLEXO SOFA - CZĘŚĆ TAPICEROWANA, 115-210	4-6	0,5885	1	DESS. 527	5220
	741050558	DUBLEXO SOFA - CZĘŚĆ TAPICEROWANA, 115-210	4-6	0,5885	1	DESS. 558	5220
	741050563	DUBLEXO SOFA - CZĘŚĆ TAPICEROWANA, 115-210	4-6	0,5885	1	DESS. 563	5220
	741050020XXX	SP SOFA - ROUND PODŁOKIETNIKI, 1 SET	15-17	0,1306	1	DESS. XXX	1450
	741050020527	SP SOFA - ROUND PODŁOKIETNIKI, 1 SET	4-6	0,1306	1	DESS. 527	1220
	741050020558	SP SOFA - ROUND PODŁOKIETNIKI, 1 SET	4-6	0,1306	1	DESS. 558	1220
	741050020563	SP SOFA - ROUND PODŁOKIETNIKI, 1 SET	4-6	0,1306	1	DESS. 563	1220
	741010020-0-2	SP NOGI DO SOFY Z PODŁOKIETNIKAMI, CHROM/CZARNY MAT	4-6	0,0272	1		1030
	741007020-10-1-2	SP STYLETTO HL NOGI DO S. Z PODŁ., JASNE DREWNO/CZARNY	4-6	0,0228	2		1030
	741007020-10-3-2	SP STYLETTO HL NOGI DO S. Z PODŁ., CIEMNE DREWNO/CZARNY	4-6	0,0228	2		1030
	741007020-10-4-2	SP STYLETTO HL NOGI DO S. Z PODŁ., CZARNE DREWNO/CZARNY	4-6	0,0228	2		1030
	741007020-11-1-2	SP STEM HL NOGI DO S. Z PODŁ., JASNE DREWNO/CZARNY	4-6	0,0234	2		1030

DUBLEXO SOFA Z PODŁOKIETNIKAMI FREJ

	95-74105027XXX-5-2	DUBLEXO SOFA, PODŁOKIETNIKI FREJ DĄB NATURALNY, 115-210	15-17	0,7215	3	DESS. XXX	8780
	95-74105027527-5-2	DUBLEXO SOFA, PODŁOKIETNIKI FREJ DĄB NATURALNY, 115-210	4-6	0,7215	3	DESS. 527	8060
	95-74105027558-5-2	DUBLEXO SOFA, PODŁOKIETNIKI FREJ DĄB NATURALNY, 115-210	4-6	0,7215	3	DESS. 558	8060
	95-74105027563-5-2	DUBLEXO SOFA, PODŁOKIETNIKI FREJ DĄB NATURALNY, 115-210	4-6	0,7215	3	DESS. 563	8060
	95-74105027XXX-7-2	DUBLEXO SOFA, PODŁOK. FREJ DĄB BARW. „SMOKED”, 115-210	15-17	0,7215	3	DESS. XXX	8780
	95-74105027527-7-2	DUBLEXO SOFA, PODŁOK. FREJ DĄB BARW. „SMOKED”, 115-210	4-6	0,7215	3	DESS. 527	8060
	95-74105027558-7-2	DUBLEXO SOFA, PODŁOK. FREJ DĄB BARW. „SMOKED”, 115-210	4-6	0,7215	3	DESS. 558	8060
	95-74105027563-7-2	DUBLEXO SOFA, PODŁOK. FREJ DĄB BARW. „SMOKED”, 115-210	4-6	0,7215	3	DESS. 563	8060

DUBLEXO FOTEL Z PODŁOKIETNIKAMI FREJ

	95-74105126XXX-5-2	DUBLEXO FOTEL, PODŁOKIETNIKI FREJ DĄB NATURALNY, 115-90	15-17	0,3890	3	DESS. XXX	5860
	95-74105126527-5-2	DUBLEXO FOTEL, PODŁOKIETNIKI FREJ DĄB NATURALNY, 115-90	4-6	0,3890	3	DESS. 527	5450
	95-74105126558-5-2	DUBLEXO FOTEL, PODŁOKIETNIKI FREJ DĄB NATURALNY, 115-90	4-6	0,3890	3	DESS. 558	5450
	95-74105126563-5-2	DUBLEXO FOTEL, PODŁOKIETNIKI FREJ DĄB NATURALNY, 115-90	4-6	0,3890	3	DESS. 563	5450
	95-74105126XXX-7-2	DUBLEXO FOTEL, PODŁOK. FREJ DĄB BARW. „SMOKED”, 115-210	15-17	0,3890	3	DESS. XXX	5860
	95-74105126527-7-2	DUBLEXO FOTEL, PODŁOK. FREJ DĄB BARW. „SMOKED”, 115-210	4-6	0,3890	3	DESS. 527	5450
	95-74105126558-7-2	DUBLEXO FOTEL, PODŁOK. FREJ DĄB BARW. „SMOKED”, 115-210	4-6	0,3890	3	DESS. 558	5450
	95-74105126563-7-2	DUBLEXO FOTEL, PODŁOK. FREJ DĄB BARW. „SMOKED”, 115-210	4-6	0,3890	3	DESS. 563	5450

DUBLEXO SOFA Z PODŁOKIETNIKAMI LAUGE

	95-74105057XXX-3-2	DUBLEXO SOFA, NOGI/PODŁOKIETNIKI LAUGE ORZECH, 115-210	15-17	0,6853	3	DESS. XXX	8390
	95-74105057527-3-2	DUBLEXO SOFA, NOGI/PODŁOKIETNIKI LAUGE ORZECH, 115-210	4-6	0,6853	3	DESS. 527	7670
	95-74105057558-3-2	DUBLEXO SOFA, NOGI/PODŁOKIETNIKI LAUGE ORZECH, 115-210	4-6	0,6853	3	DESS. 558	7670
	95-74105057563-3-2	DUBLEXO SOFA, NOGI/PODŁOKIETNIKI LAUGE ORZECH, 115-210	4-6	0,6853	3	DESS. 563	7670

DUBLEXO FOTEL Z NOGAMI LAUGE

	95-74105156XXX-2	DUBLEXO FOTEL, NOGI LAUGE CZARNY MAT, 115-90	15-17	0,2851	2	DESS. XXX	4080
	95-74105156527-2	DUBLEXO FOTEL, NOGI LAUGE CZARNY MAT, 115-90	4-6	0,2851	2	DESS. 527	3670
	95-74105156558-2	DUBLEXO FOTEL, NOGI LAUGE CZARNY MAT, 115-90	4-6	0,2851	2	DESS. 558	3670
	95-74105156563-2	DUBLEXO FOTEL, NOGI LAUGE CZARNY MAT, 115-90	4-6	0,2851	2	DESS. 563	3670

MODULAR

NR.ART.	OPIS	TYGODNIE	M3	CLL.	TKANINA	CENA
---------	------	----------	----	------	---------	------

MODULAR

OLDSCHOOL SOFA

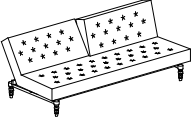
	95-741018XXX-4-2	OLDSCHOOL SOFA, NOGI RETRO CIEMNE DREWNO/CZARNY MAT, 115-200	15-17	0,5108	2	DESS. XXX	7060
	95-741018461-4-2	OLDSCHOOL SOFA, NOGI RETRO CIEMNE DREWNO/CZARNY MAT, 115-200	4-6	0,5108	2	DESS. 461	6170

OLDSCHOOL FOTEL

	95-741019XXX-4-2	OLDSCHOOL FOTEL, NOGI RETRO CIEMNE DREWNO/CZARNY MAT, 115-90	15-17	0,2331	2	DESS. XXX	4230
	95-741019461-4-2	OLDSCHOOL FOTEL, NOGI RETRO CIEMNE DREWNO/CZARNY MAT, 115-90	4-6	0,2331	2	DESS. 461	3780

COMPACT

NR.ART.	OPIS	TYGODNIE	M3	CLL.	TKANINA	CENA
COMPACT						

CUBED 02 FOTEL, NOGI CHROM, 90-200

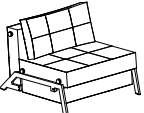
	95-744004XXX-0-2	CUBED 02 FOTEL, NOGI CHROM, 90-200	8-10	0,4663	2	DESS. XXX	5870
	95-744004528-0-2	CUBED 02 FOTEL, NOGI CHROM, 90-200	4-6	0,4663	2	DESS. 528	5140
	95-744004565-0-2	CUBED 02 FOTEL, NOGI CHROM, 90-200	4-6	0,4663	2	DESS. 565	5140
	95-744004581-0-2	CUBED 02 FOTEL, NOGI CHROM, 90-200	4-6	0,4663	2	DESS. 581	5140
	95-744004612-0-2	CUBED 02 FOTEL, NOGI CHROM, 90-200	4-6	0,4663	2	DESS. 612	5140

CUBED 02 FOTEL, NOGI DĄB, 90-200

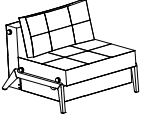
	95-744004XXX-5-2	CUBED 02 FOTEL, NOGI DĄB NATURALNY, 90-200	8-10	0,4713	2	DESS. XXX	6870
	95-744004528-5-2	CUBED 02 FOTEL, NOGI DĄB NATURALNY, 90-200	4-6	0,4713	2	DESS. 528	6140
	95-744004565-5-2	CUBED 02 FOTEL, NOGI DĄB NATURALNY, 90-200	4-6	0,4713	2	DESS. 565	6140
	95-744004581-5-2	CUBED 02 FOTEL, NOGI DĄB NATURALNY, 90-200	4-6	0,4713	2	DESS. 581	6140
	95-744004612-5-2	CUBED 02 FOTEL, NOGI DĄB NATURALNY, 90-200	4-6	0,4713	2	DESS. 612	6140

CUBED 02 FOTEL, NOGI ALUMINIUM, 90-200

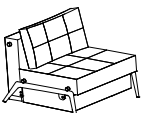
	95-744004XXX-6-2	CUBED 02 FOTEL, NOGI ALUMINIUM, 90-200	8-10	0,4721	2	DESS. XXX	6870
	95-744004528-6-2	CUBED 02 FOTEL, NOGI ALUMINIUM, 90-200	4-6	0,4721	2	DESS. 528	6140
	95-744004565-6-2	CUBED 02 FOTEL, NOGI ALUMINIUM, 90-200	4-6	0,4721	2	DESS. 565	6140
	95-744004581-6-2	CUBED 02 FOTEL, NOGI ALUMINIUM, 90-200	4-6	0,4721	2	DESS. 581	6140
	95-744004612-6-2	CUBED 02 FOTEL, NOGI ALUMINIUM, 90-200	4-6	0,4721	2	DESS. 612	6140

CUBED 02 FOTEL Z PODŁOKIETNIKAMI, 90-200

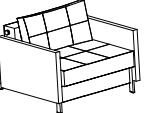
	95-744004020XXX-2	CUBED 02 FOTEL Z PODŁOKIETNIKAMI, 90-200	8-10	0,5399	3	DESS. XXX	7070
	95-744004020528-2	CUBED 02 FOTEL Z PODŁOKIETNIKAMI, 90-200	4-6	0,5399	3	DESS. 528	6180
	95-744004020565-2	CUBED 02 FOTEL Z PODŁOKIETNIKAMI, 90-200	4-6	0,5399	3	DESS. 565	6180
	95-744004020581-2	CUBED 02 FOTEL Z PODŁOKIETNIKAMI, 90-200	4-6	0,5399	3	DESS. 581	6180
	95-744004020612-2	CUBED 02 FOTEL Z PODŁOKIETNIKAMI, 90-200	4-6	0,5399	3	DESS. 612	6180

CUBED 02 SOFA, NOGI CHROM, 140-200

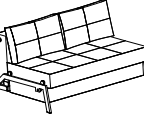
	95-744002XXX-0-2	CUBED 02 SOFA, NOGI CHROM, 140-200	8-10	0,6515	3	DESS. XXX	7840
	95-744002528-0-2	CUBED 02 SOFA, NOGI CHROM, 140-200	4-6	0,6515	3	DESS. 528	6820
	95-744002565-0-2	CUBED 02 SOFA, NOGI CHROM, 140-200	4-6	0,6515	3	DESS. 565	6820
	95-744002581-0-2	CUBED 02 SOFA, NOGI CHROM, 140-200	4-6	0,6515	3	DESS. 581	6820
	95-744002612-0-2	CUBED 02 SOFA, NOGI CHROM, 140-200	4-6	0,6515	3	DESS. 612	6820

CUBED 02 SOFA, NOGI DĄB, 140-200

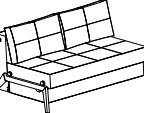
	95-744002XXX-5-2	CUBED 02 SOFA, NOGI DĄB, 140-200	8-10	0,6565	3	DESS. XXX	8840
	95-744002528-5-2	CUBED 02 SOFA, NOGI DĄB, 140-200	4-6	0,6565	3	DESS. 528	7820
	95-744002565-5-2	CUBED 02 SOFA, NOGI DĄB, 140-200	4-6	0,6565	3	DESS. 565	7820
	95-744002581-5-2	CUBED 02 SOFA, NOGI DĄB, 140-200	4-6	0,6565	3	DESS. 581	7820
	95-744002612-5-2	CUBED 02 SOFA, NOGI DĄB, 140-200	4-6	0,6565	3	DESS. 612	7820

CUBED 02 SOFA, NOGI ALUMINIUM, 140-200

	95-744002XXX-6-2	CUBED 02 SOFA, NOGI ALUMINIUM, 140-200	8-10	0,6573	3	DESS. XXX	8840
	95-744002528-6-2	CUBED 02 SOFA, NOGI ALUMINIUM, 140-200	4-6	0,6573	3	DESS. 528	7820
	95-744002565-6-2	CUBED 02 SOFA, NOGI ALUMINIUM, 140-200	4-6	0,6573	3	DESS. 565	7820
	95-744002581-6-2	CUBED 02 SOFA, NOGI ALUMINIUM, 140-200	4-6	0,6573	3	DESS. 581	7820
	95-744002612-6-2	CUBED 02 SOFA, NOGI ALUMINIUM, 140-200	4-6	0,6573	3	DESS. 612	7820

CUBED 02 SOFA Z PODŁOKIETNIKAMI, 140-200

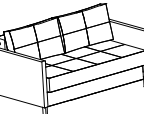
	95-744002020XXX-2	CUBED 02 SOFA Z PODŁOKIETNIKAMI, 140-200	8-10	0,7298	4	DESS. XXX	9090
	95-744002020528-2	CUBED 02 SOFA Z PODŁOKIETNIKAMI, 140-200	4-6	0,7298	4	DESS. 528	7910
	95-744002020565-2	CUBED 02 SOFA Z PODŁOKIETNIKAMI, 140-200	4-6	0,7298	4	DESS. 565	7910
	95-744002020581-2	CUBED 02 SOFA Z PODŁOKIETNIKAMI, 140-200	4-6	0,7298	4	DESS. 581	7910
	95-744002020612-2	CUBED 02 SOFA Z PODŁOKIETNIKAMI, 140-200	4-6	0,7298	4	DESS. 612	7910

COMPACT

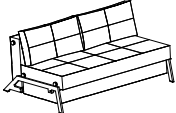
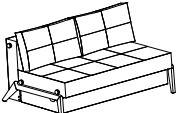
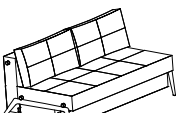
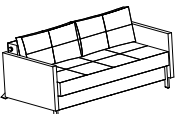
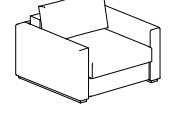
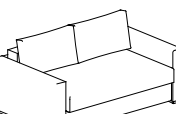
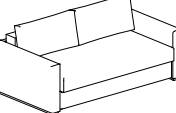
	NR.ART.	OPIS	TYGODNIE	M3	CLL.	TKANINA	CENA
COMPACT							
CUBED 02 SOFA, NOGI CHROM, 160-200							
	95-744029XXX-0-2	CUBED 02 SOFA, NOGI CHROM, 160-200	8-10	0,7402	3	DESS. XXX	8940
	95-744029528-0-2	CUBED 02 SOFA, NOGI CHROM, 160-200	4-6	0,7402	3	DESS. 528	7750
	95-744029565-0-2	CUBED 02 SOFA, NOGI CHROM, 160-200	4-6	0,7402	3	DESS. 565	7750
	95-744029581-0-2	CUBED 02 SOFA, NOGI CHROM, 160-200	4-6	0,7402	3	DESS. 581	7750
	95-744029612-0-2	CUBED 02 SOFA, NOGI CHROM, 160-200	4-6	0,7402	3	DESS. 612	7750
CUBED 02 SOFA, NOGI DĄB, 160-200							
	95-744029XXX-5-2	CUBED 02 SOFA, NOGI DĄB, 160-200	8-10	0,7452	3	DESS. XXX	9940
	95-744029528-5-2	CUBED 02 SOFA, NOGI DĄB, 160-200	4-6	0,7452	3	DESS. 528	8750
	95-744029565-5-2	CUBED 02 SOFA, NOGI DĄB, 160-200	4-6	0,7452	3	DESS. 565	8750
	95-744029581-5-2	CUBED 02 SOFA, NOGI DĄB, 160-200	4-6	0,7452	3	DESS. 581	8750
	95-744029612-5-2	CUBED 02 SOFA, NOGI DĄB, 160-200	4-6	0,7452	3	DESS. 612	8750
CUBED 02 SOFA, NOGI ALUMINIUM, 160-200							
	95-744029XXX-6-2	CUBED 02 SOFA, NOGI ALUMINIUM, 160-200	8-10	0,7460	3	DESS. XXX	9940
	95-744029528-6-2	CUBED 02 SOFA, NOGI ALUMINIUM, 160-200	4-6	0,7460	3	DESS. 528	8750
	95-744029565-6-2	CUBED 02 SOFA, NOGI ALUMINIUM, 160-200	4-6	0,7460	3	DESS. 565	8750
	95-744029581-6-2	CUBED 02 SOFA, NOGI ALUMINIUM, 160-200	4-6	0,7460	3	DESS. 581	8750
	95-744029612-6-2	CUBED 02 SOFA, NOGI ALUMINIUM, 160-200	4-6	0,7460	3	DESS. 612	8750
CUBED 02 SOFA Z PODŁOKIETNIKAMI, 160-200							
	95-744029020XXX-2	CUBED 02 SOFA Z PODŁOKIETNIKAMI, 160-200	8-10	0,8188	4	DESS. XXX	10190
	95-744029020528-2	CUBED 02 SOFA Z PODŁOKIETNIKAMI, 160-200	4-6	0,8188	4	DESS. 528	8840
	95-744029020565-2	CUBED 02 SOFA Z PODŁOKIETNIKAMI, 160-200	4-6	0,8188	4	DESS. 565	8840
	95-744029020581-2	CUBED 02 SOFA Z PODŁOKIETNIKAMI, 160-200	4-6	0,8188	4	DESS. 581	8840
	95-744029020612-2	CUBED 02 SOFA Z PODŁOKIETNIKAMI, 160-200	4-6	0,8188	4	DESS. 612	8840
COSIAL FOTEL Z PODŁOKIETNIKAMI, 80-195							
	95-585002020XXX-01-2	COSIAL FOTEL Z PODŁOKIETNIKAMI, 80-195	15-17	0,6970	2	DESS. XXX	8270
	95-585002020580-01-2	COSIAL FOTEL Z PODŁOKIETNIKAMI, 80-195	4-6	0,6970	2	DESS. 580	7180
	95-585002020586-01-2	COSIAL FOTEL Z PODŁOKIETNIKAMI, 80-195	4-6	0,6970	2	DESS. 586	7180
COSIAL SOFA Z PODŁOKIETNIKAMI, 140-195							
	95-585003020XXX-01-2	COSIAL SOFA Z PODŁOKIETNIKAMI, 140-195	15-17	1,0264	3	DESS. XXX	10800
	95-585003020580-01-2	COSIAL SOFA Z PODŁOKIETNIKAMI, 140-195	4-6	1,0264	3	DESS. 580	9390
	95-585003020586-01-2	COSIAL SOFA Z PODŁOKIETNIKAMI, 140-195	4-6	1,0264	3	DESS. 586	9390
COSIAL SOFA Z PODŁOKIETNIKAMI, 160-195							
	95-585004020XXX-01-2	COSIAL SOFA Z PODŁOKIETNIKAMI, 160-195	15-17	1,2063	3	DESS. XXX	11880
	95-585004020580-01-2	COSIAL SOFA Z PODŁOKIETNIKAMI, 160-195	4-6	1,2063	3	DESS. 580	10330
	95-585004020586-01-2	COSIAL SOFA Z PODŁOKIETNIKAMI, 160-195	4-6	1,2063	3	DESS. 586	10330

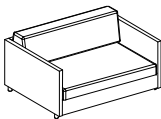
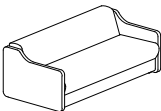
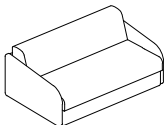
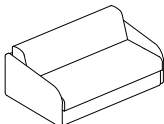
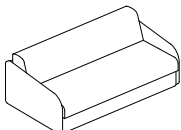
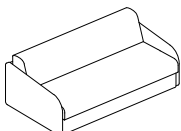

COMPACT

	NR.ART.	OPIS	TYGODNIE	M3	CLL.	TKANINA	CENA
COMPACT							
OLAN SOFA, 140-195							
	744035140XXX-5-2 744035140565-5-2	OLAN SOFA, NOGI DĄB, 140-195 OLAN SOFA, NOGI DĄB, 140-195	8-10 4-6	0,9920 0,9920	1 1	DESS. XXX DESS. 565	6790 5900
VITHUS SOFA, 140-195							
	95-598140XXX-01-4 95-598140590F-01-4	VITHUS SOFA, NOGI CZARNE DREWNO, 140-195 VITHUS SOFA, NOGI CZARNE DREWNO, 140-195	8-10 4-6	1,1852 1,1852	4 4	DESS. XXX DESS. 590	9200 8000
EIVOR SPRING SOFA, 140-195							
	95-592140XXXS-01-4 95-592140565S-01-4 95-592140586S-01-4	EIVOR SPRING SOFA, NOGI CZARNE DREWNO, 140-195 EIVOR SPRING SOFA, NOGI CZARNE DREWNO, 140-195 EIVOR SPRING SOFA, NOGI CZARNE DREWNO, 140-195	8-10 4-6 4-6	1,1690 1,1690 1,1690	4 4 4	DESS. XXX DESS. 565 DESS. 586	11850 10090 10090
EIVOR DUAL SOFA, 140-195							
	95-592140XXXD-01-4 95-592140565D-01-4 95-592140586D-01-4	EIVOR DUAL SOFA, NOGI CZARNE DREWNO, 140-195 EIVOR DUAL SOFA, NOGI CZARNE DREWNO, 140-195 EIVOR DUAL SOFA, NOGI CZARNE DREWNO, 140-195	8-10 4-6 4-6	1,1690 1,1690 1,1690	4 4 4	DESS. XXX DESS. 565 DESS. 586	11850 10090 10090
EIVOR SPRING SOFA, 160-195							
	95-592160XXXS-01-4 95-592160565S-01-4 95-592160586S-01-4	EIVOR SPRING SOFA, NOGI CZARNE DREWNO, 160-195 EIVOR SPRING SOFA, NOGI CZARNE DREWNO, 160-195 EIVOR SPRING SOFA, NOGI CZARNE DREWNO, 160-195	8-10 4-6 4-6	1,3008 1,3008 1,3008	4 4 4	DESS. XXX DESS. 565 DESS. 586	12580 10940 10940
EIVOR DUAL SOFA, 160-195							
	95-592160XXXD-01-4 95-592160565D-01-4 95-592160586D-01-4	EIVOR DUAL SOFA, NOGI CZARNE DREWNO, 160-195 EIVOR DUAL SOFA, NOGI CZARNE DREWNO, 160-195 EIVOR DUAL SOFA, NOGI CZARNE DREWNO, 160-195	8-10 4-6 4-6	1,3008 1,3008 1,3008	4 4 4	DESS. XXX DESS. 565 DESS. 586	12580 10940 10940

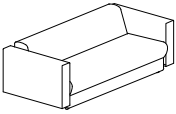
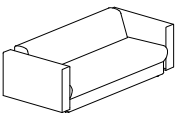
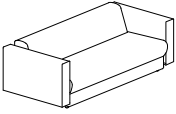
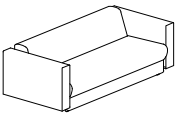

COMPACT

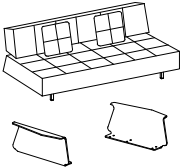
	NR.ART.	OPIS	TYGODNIE	M3	CLL.	TKANINA	CENA
COMPACT							
KILLIAN SPRING SOFA, 140-195							
	95-592140XXS-02-4	KILLIAN SPRING SOFA, NOGI CZARNE DREWNO, 140-195	8-10	1,2849	4	DESS. XXX	12780
	95-592140565S-02-4	KILLIAN SPRING SOFA, NOGI CZARNE DREWNO, 140-195	4-6	1,2849	4	DESS. 565	11010
	95-592140586S-02-4	KILLIAN SPRING SOFA, NOGI CZARNE DREWNO, 140-195	4-6	1,2849	4	DESS. 586	11010
KILLIAN DUAL SOFA, 140-195							
	95-592140XXD-02-4	KILLIAN DUAL SOFA, NOGI CZARNE DREWNO, 140-195	8-10	1,2849	4	DESS. XXX	12780
	95-592140565D-02-4	KILLIAN DUAL SOFA, NOGI CZARNE DREWNO, 140-195	4-6	1,2849	4	DESS. 565	11010
	95-592140586D-02-4	KILLIAN DUAL SOFA, NOGI CZARNE DREWNO, 140-195	4-6	1,2849	4	DESS. 586	11010
KILLIAN SPRING SOFA, 160-195							
	95-592160XXS-02-4	KILLIAN SPRING SOFA, NOGI CZARNE DREWNO, 160-195	8-10	1,4167	4	DESS. XXX	13510
	95-592160565S-02-4	KILLIAN SPRING SOFA, NOGI CZARNE DREWNO, 160-195	4-6	1,4167	4	DESS. 565	11860
	95-592160586S-02-4	KILLIAN SPRING SOFA, NOGI CZARNE DREWNO, 160-195	4-6	1,4167	4	DESS. 586	11860
KILLIAN DUAL SOFA, 160-195							
	95-592160XXD-02-4	KILLIAN DUAL SOFA, NOGI CZARNE DREWNO, 160-195	8-10	1,4167	4	DESS. XXX	13510
	95-592160565D-02-4	KILLIAN DUAL SOFA, NOGI CZARNE DREWNO, 160-195	4-6	1,4167	4	DESS. 565	11860
	95-592160586D-02-4	KILLIAN DUAL SOFA, NOGI CZARNE DREWNO, 160-195	4-6	1,4167	4	DESS. 586	11860

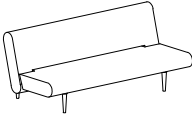
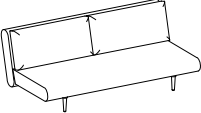
UNIQUE

	NR.ART.	OPIS	TYGODNIE	M3	CLL.	TKANINA	CENA
UNIQUE							
LONG HORN DELUXE EXCESS LOUNGER SOFA							
	95-742032XXX-8 95-742032565-8	LONG HORN EXCESS SOFA Z PODUSZKAMI, 140-210 LONG HORN EXCESS SOFA Z PODUSZKAMI, 140-210	15-17 4-6	1,0372 1,0372	4 3	DESS. XXX DESS. 565	10520 9320
	742032001-3	LONG HORN PODŁOKIETNIKI, ORZECH, 1 SET	4-6	0,1305	1		3150
	LONG HORN DELUXE EXCESS LOUNGER FOTEL						
	95-742033XXX-8 95-742033565-8	LONG HORN EXCESS FOTEL, 115-85 LONG HORN EXCESS FOTEL, 115-85	15-17 4-6	0,2850 0,2850	2 2	DESS. XXX DESS. 565	5030 4580
	UNFURL SOFA						
	772001XXX-10-3-2	UNFURL SOFA, NOGI CIEMNE DREWNO/CZARNY, 120-200	15-17	0,4877	1	DESS. XXX	5550
	772001217-10-3-2	UNFURL SOFA, NOGI CIEMNE DREWNO/CZARNY, 120-200	4-6	0,4877	1	DESS. 217	4750
	772001534-10-3-2	UNFURL SOFA, NOGI CIEMNE DREWNO/CZARNY, 120-200	4-6	0,4877	1	DESS. 534	4750
	772001554-10-3-2	UNFURL SOFA, NOGI CIEMNE DREWNO/CZARNY, 120-200	4-6	0,4877	1	DESS. 554	4750
	772001531534-10-3-2	UNFURL SOFA, NOGI CIEMNE DREWNO/CZARNY, 120-200	4-6	0,4877	1	DESS. 531/534	4750
UNFURL LOUNGER SOFA							
	95-772012XXX-10-3-2	UNFURL LOUNGER, NOGI CIEMNE DREWNO/CZARNY, 140-200	15-17	0,7792	2	DESS. XXX	8180
	95-772012518-10-3-2	UNFURL LOUNGER, NOGI CIEMNE DREWNO/CZARNY, 140-200	4-6	0,7792	2	DESS. 518	6940
	95-772012533-10-3-2	UNFURL LOUNGER, NOGI CIEMNE DREWNO/CZARNY, 140-200	4-6	0,7792	2	DESS. 533	6940

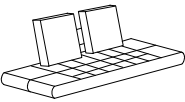
DAYBEDS

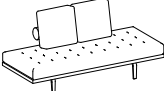
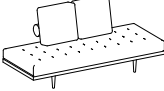
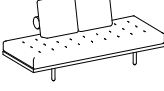
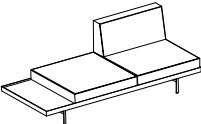

	NR.ART.	OPIS	TYGODNIE	M3	CLL.	TKANINA	CENA
DAYBEDS							
GHIA SOFA							
	743020XXX	GHIA SOFA - CZĘŚĆ TAPICEROWANA, 80-210	15-17	0,3100	1	DESS. XXX	5160
	743020318	GHIA SOFA - CZĘŚĆ TAPICEROWANA, 80-210	4-6	0,3100	1	DESS. 318	4400
	743020525	GHIA SOFA - CZĘŚĆ TAPICEROWANA, 80-210	4-6	0,3100	1	DESS. 525	4400
	743020550	GHIA SOFA - CZĘŚĆ TAPICEROWANA, 80-210	4-6	0,3100	1	DESS. 550	4400
	743020551	GHIA SOFA - CZĘŚĆ TAPICEROWANA, 80-210	4-6	0,3100	1	DESS. 551	4400
	743020-0-2	GHIA NOGI, CHROM/CZARNY MAT	4-6	0,1560	1		940
	743021-5-2	GHIA NOGI, DĄB NATURALNY LAKIEROWANY/CZARNY MAT	4-6	0,1663	1		1550
	743020-2-2	GHIA LASER NOGI, CZARNY MAT	4-6	0,1560	1		1550
ROLLO BOW SOFA							
	95-4951508XXX-12-5+	ROLLO BOW/CLASSIC ROUND/PODUSZKI/POKROWIEC, 80-200	4-6	0,3242	6	DESS. XXX	4460
	95-4951608XXX-12-5+	ROLLO BOW/SPRING ROUND/PODUSZKI/POKROWIEC, 80-200	4-6	0,3502	6	DESS. XXX	5030
ROLLO STYLETTO SOFA							
	95-4951508XXX-10-3+	ROLLO STYLETTO/CLASSIC ROUND/PODUSZKI/POKROWIEC, 80-200	4-6	0,3235	6	DESS. XXX	4460
	95-4951608XXX-10-3+	ROLLO STYLETTO/SPRING ROUND/PODUSZKI/POKROWIEC, 80-200	4-6	0,3495	6	DESS. XXX	5030
ROLLO STEM SOFA							
	95-4951508XXX-11-1+	ROLLO STEM/CLASSIC ROUND/PODUSZKI/POKROWIEC, 80-200	4-6	0,3243	6	DESS. XXX	4460
	95-4951608XXX-11-1+	ROLLO STEM/SPRING ROUND/PODUSZKI/POKROWIEC, 80-200	4-6	0,3503	6	DESS. XXX	5030
PURI SOFA							
	95-745045XXX-3-2	PURI SOFA, STOLIK ORZECH LAK., NOGI CZARNE, 80-195	8-10	0,4159	4	DESS. XXX	6440
	95-745045575-3-2	PURI SOFA, STOLIK ORZECH LAK., NOGI CZARNE, 80-195	4-6	0,4159	4	DESS. 575	5590
	95-745045580-3-2	PURI SOFA, STOLIK ORZECH LAK., NOGI CZARNE, 80-195	4-6	0,4159	4	DESS. 580	5590
	95-745045581-3-2	PURI SOFA, STOLIK ORZECH LAK., NOGI CZARNE, 80-195	4-6	0,4159	4	DESS. 581	5590
	95-745045584-3-2	PURI SOFA, STOLIK ORZECH LAK., NOGI CZARNE, 80-195	4-6	0,4159	4	DESS. 584	5590
	95-745045XXX-5-2	PURI SOFA, STOLIK DĄB NATURALNY LAK., NOGI CZARNE, 80-195	8-10	0,4159	4	DESS. XXX	6440
	95-745045575-5-2	PURI SOFA, STOLIK DĄB NATURALNY LAK., NOGI CZARNE, 80-195	4-6	0,4159	4	DESS. 575	5590
	95-745045580-5-2	PURI SOFA, STOLIK DĄB NATURALNY LAK., NOGI CZARNE, 80-195	4-6	0,4159	4	DESS. 580	5590
	95-745045581-5-2	PURI SOFA, STOLIK DĄB NATURALNY LAK., NOGI CZARNE, 80-195	4-6	0,4159	4	DESS. 581	5590
	95-745045584-5-2	PURI SOFA, STOLIK DĄB NATURALNY LAK., NOGI CZARNE, 80-195	4-6	0,4159	4	DESS. 584	5590
	745045XXX-02	PURI PODUSZKA KOMPLETNA, 1 PCS.	8-10	0,0631	1		290
	745045BXXX-01	PURI POKROWIEC NA CZĘŚĆ TAPICEROWANĄ SIEDZISKA, 2 PCS	8-10	0,0141	1		450
	745045BXXX-02	PURI POKROWIEC NA PODUSZKĘ, 1 PCS.	8-10	0,0051	1		170
	745045-3	PURI STOLIK ORZECH LAKIEROWANY, 79-36	4-6	0,0167	1		1190
	745045-5	PURI STOLIK DĄB NATURALNY LAKIEROWANY, 79-36	4-6	0,0167	1		1190

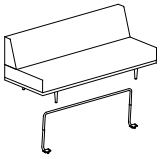
DAYBEDS

	NR.ART.	OPIS	TYGODNIE	M3	CLL.	TKANINA	CENA
VANADIS SOFA							
	740027XXX-10-5	VANADIS SOFA, NOGI STYLELTO JASNE DREWNO, 90-200	8-10	0,6962	2	DESS. XXX	4630
	740027563-10-5	VANADIS SOFA, NOGI STYLELTO JASNE DREWNO, 90-200	4-6	0,6962	2	DESS. 563	4040
	740027001-2	VANADIS WSPORNIK OPARCIA, CZARNY MAT	4-6	0,0354	1		290

DAYBEDS

ZEAL SOFA

	740021XXX-2	ZEAL SOFA - CZĘŚĆ TAPICEROWANA, 70-200	15-17	0,2662	1	DESS. XXX	3500	
	740021216-2	ZEAL SOFA - CZĘŚĆ TAPICEROWANA, 70-200	4-6	0,2662	1	DESS. 216	2860	
	740021316-2	ZEAL SOFA - CZĘŚĆ TAPICEROWANA, 70-200	4-6	0,2662	1	DESS. 316	2860	
	740021515-2	ZEAL SOFA - CZĘŚĆ TAPICEROWANA, 70-200	4-6	0,2662	1	DESS. 515	2860	
	740021552-2	ZEAL SOFA - CZĘŚĆ TAPICEROWANA, 70-200	4-6	0,2662	1	DESS. 552	2860	
	740021565-2	ZEAL SOFA - CZĘŚĆ TAPICEROWANA, 70-200	4-6	0,2662	1	DESS. 565	2860	
	740021581-2	ZEAL SOFA - CZĘŚĆ TAPICEROWANA, 70-200	4-6	0,2662	1	DESS. 581	2860	
		740021-12-5	BOW HH NOGI + PODUSZKA, DĄB NATURALNY LAKIEROWANY	4-6	0,0713	1		750
		740021-10-3	STYLELTO HH NOGI + PODUSZKA, CIEMNE DREWNO	4-6	0,0713	1		750
		740021-11-1	STEM HH NOGI + PODUSZKA, JASNE DREWNO	4-6	0,0713	1		750
	740021-17-2	LASER HH NOGI + PODUSZKA, CZARNY MAT	4-6	0,0713	1		930	
	740021-19-6	STRAW HH NOGI + PODUSZKA, ALUMINIUM	4-6	0,0713	1		930	

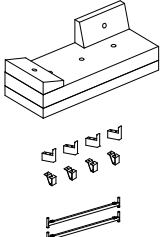

SIGMUND SOFA

	745059004XXX	SIGMUND SOFA, 160-200	8-10	0,7391	1	DESS. XXX	5790
	745059004579	SIGMUND SOFA, 160-200	4-6	0,7391	1	DESS. 579	5030
	745059004595	SIGMUND SOFA, 160-200	4-6	0,7391	1	DESS. 595	5030
	745057-5	DB DRIP NOGI, DĄB NATURALNY LAKIEROWANY, 4 SZTUKI	4-6	0,0030	1		340
	745058-6	DB CUBE NOGI, ALUMINIUM, 4 SZTUKI	4-6	0,0014	1		340
	745059-2	DB INDU NOGI CZARNE METALOWE, 1 KPL	4-6	0,0092	1		340

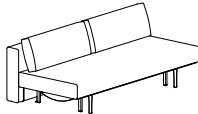
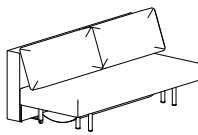
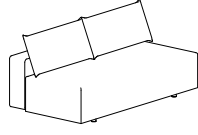
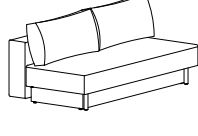
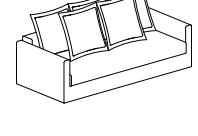
SLYDERS

	NR.ART.	OPIS	TYGODNIE	M3	CLL.	TKANINA	CENA
SLYDERS – SOFY ZE ZDEJMOWANYM POKROWCEM							
CONLIX SOFA							
	95-722081XXX-18-1-2	CONLIX SOFA, NOGI JASNE DREWNO, 140-200	8-10	0,6526	2	DESS. XXX	7250
	95-722081318-18-1-2	CONLIX SOFA, NOGI JASNE DREWNO, 140-200	4-6	0,6526	2	DESS. 318	6290
	95-722081531-18-1-2	CONLIX SOFA, NOGI JASNE DREWNO, 140-200	4-6	0,6526	2	DESS. 531	6290
	95-722081533-18-1-2	CONLIX SOFA, NOGI JASNE DREWNO, 140-200	4-6	0,6526	2	DESS. 533	6290
	95-722081578-18-1-2	CONLIX SOFA, NOGI JASNE DREWNO, 140-200	4-6	0,6526	2	DESS. 578	6290
	95-722081583-18-1-2	CONLIX SOFA, NOGI JASNE DREWNO, 140-200	4-6	0,6526	2	DESS. 583	6290
	722081BXXX	CONLIX POKROWCE - KOMPLET, 140-200	8-10	0,0355	1	DESS. XXX	1530
ACHILLAS SOFA							
	95-722069XXX-2	ACHILLAS, NOGI CZARNE METALOWE, 155-200	8-10	0,8598	3	DESS. XXX	8690
	95-722069317-2	ACHILLAS, NOGI CZARNE METALOWE, 155-200	4-6	0,8598	3	DESS. 317	7540
	95-722069587-2	ACHILLAS, NOGI CZARNE METALOWE, 155-200	4-6	0,8598	3	DESS. 587	7540
	95-722069590-2	ACHILLAS, NOGI CZARNE METALOWE, 155-200	4-6	0,8598	3	DESS. 590	7540
	95-722069595-2	ACHILLAS, NOGI CZARNE METALOWE, 155-200	4-6	0,8598	3	DESS. 595	7540
	722069BXXX	ACHILLAS POKROWCE - KOMPLET, 155-200	8-10	0,0355	1	DESS. XXX	1680
REVIVUS SOFA							
	95-543121XXX-2	REVIVUS SOFA, NOGI CZARNE METALOWE, 135-200	8-10	0,9255	3	DESS. XXX	8740
	95-543121571-2	REVIVUS SOFA, NOGI CZARNE METALOWE, 135-200	4-6	0,9255	3	DESS. 571	7540
	95-543121573-2	REVIVUS SOFA, NOGI CZARNE METALOWE, 135-200	4-6	0,9255	3	DESS. 573	7540
	95-543121575-2	REVIVUS SOFA, NOGI CZARNE METALOWE, 135-200	4-6	0,9255	3	DESS. 575	7540
	543121001-2	REVIVUS STELAŻ, CZARNY METALOWY, 135-200	4-6	0,2200	1		3690
	543121201-01	REVIVUS SIEDZISKO/OPARCIE/PODUSZKI - BEZ POKROWCÓW	4-6	0,6700	1		3520
	543121BXXX	REVIVUS POKROWCE - KOMPLET, 135-200	8-10	0,0355	1	DESS. XXX	1530
MERGA SOFA							
	95-543120XXX-4	MERGA SOFA, NOGI CZARNE DREWNO, 140-200	8-10	0,8944	2	DESS. XXX	7250
	95-543120318-4	MERGA SOFA, NOGI CZARNE DREWNO, 140-200	4-6	0,8944	2	DESS. 318	6290
	95-543120533-4	MERGA SOFA, NOGI CZARNE DREWNO, 140-200	4-6	0,8944	2	DESS. 533	6290
	95-543120534-4	MERGA SOFA, NOGI CZARNE DREWNO, 140-200	4-6	0,8944	2	DESS. 534	6290
	543120BXXX	MERGA POKROWCE - KOMPLET, 140-200	8-10	0,0300	1	DESS. XXX	1350
PASCALA SOFA							
	95-722070020XXX-01	PASCALA SOFA, 140-200	8-10	0,9747	3	DESS. XXX	11140
	95-722070020571-01	PASCALA SOFA, 140-200	4-6	0,9747	3	DESS. 571	9680
	95-722070020573-01	PASCALA SOFA, 140-200	4-6	0,9747	3	DESS. 573	9680
	95-722070020574-01	PASCALA SOFA, 140-200	4-6	0,9747	3	DESS. 574	9680
	722070BXXX	PASCALA POKROWCE - KOMPLET, 140-200	8-10	0,0502	1	DESS. XXX	2070

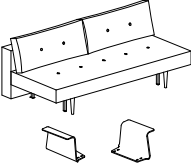
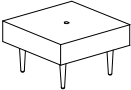
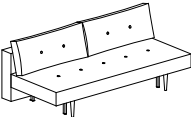
SLYDERS

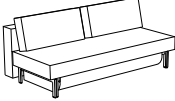
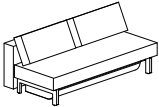
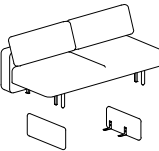
	NR.ART.	OPIS	TYGODNIE	M3	CLL.	TKANINA	CENA
SLYDERS							
RECAST PLUS SOFA - NOGI CIEMNE DREWNO							
	742050XXX-10-3-2	RECAST PLUS SOFA, CIEMNE DREWNO/CZARNY, 140-200	15-17	0,6170	1	DESS. XXX	7010
	742050515-10-3-2	RECAST PLUS SOFA, CIEMNE DREWNO/CZARNY, 140-200	4-6	0,6170	1	DESS. 515	5790
	742050552-10-3-2	RECAST PLUS SOFA, CIEMNE DREWNO/CZARNY, 140-200	4-6	0,6170	1	DESS. 552	5790
	742050020-3	RC PODŁOKIETNIKI, ORZECH, 1 SET	4-6	0,0594	1		1360
RECAST OTTOMAN PUF - NOGI CIEMNE DREWNO							
	742053XXX-10-3-2	RECAST OTTOMAN, NOGI CIEMNE DREWNO, 66-66	15-17	0,1095	1	DESS. XXX	1550
	742053515-10-3-2	RECAST OTTOMAN, NOGI CIEMNE DREWNO, 66-66	4-6	0,1095	1	DESS. 515	1360
	742053552-10-3-2	RECAST OTTOMAN, NOGI CIEMNE DREWNO, 66-66	4-6	0,1095	1	DESS. 552	1360
RECAST PLUS SOFA - NOGI JASNE DREWNO							
	742050XXX-10-1-2	RECAST PLUS, NOGI JASNE DREWNO/CZARNY, 140-200	15-17	0,6170	1	DESS. XXX	7010
	742050590-10-1-2	RECAST PLUS, NOGI JASNE DREWNO/CZARNY, 140-200	4-6	0,6170	1	DESS. 590	5790
RECAST OTTOMAN PUF - NOGI JASNE DREWNO							
	742053XXX-10-1-2	RECAST OTTOMAN, NOGI JASNE DREWNO, 66-66	15-17	0,1095	1	DESS. XXX	1550
	742053590-10-1-2	RECAST OTTOMAN, NOGI JASNE DREWNO, 66-66	4-6	0,1095	1	DESS. 590	1360
SLY SOFA (NOGI CZARNE)							
	95-543070XXX-2	SLY SOFA, NOGI CZARNY METAL, 140-200	15-17	0,7251	3	DESS. XXX	7270
	95-543070527-2	SLY SOFA, NOGI CZARNY METAL, 140-200	4-6	0,7251	3	DESS. 527	5760
	95-543070528-2	SLY SOFA, NOGI CZARNY METAL, 140-200	4-6	0,7251	3	DESS. 528	5760
	95-543070534-2	SLY SOFA, NOGI CZARNY METAL, 140-200	4-6	0,7251	3	DESS. 534	5760
	95-543070563-2	SLY SOFA, NOGI CZARNY METAL, 140-200	4-6	0,7251	3	DESS. 563	5760
SLY SOFA (NOGI DĘBOWE)							
	95-543070XXX-5-2	SLY SOFA, NOGI DĄB NATURALNY, 140-200	15-17	0,7299	3	DESS. XXX	8200
	95-543070527-5-2	SLY SOFA, NOGI DĄB NATURALNY, 140-200	4-6	0,7299	3	DESS. 527	6690
	95-543070528-5-2	SLY SOFA, NOGI DĄB NATURALNY, 140-200	4-6	0,7299	3	DESS. 528	6690
	95-543070534-5-2	SLY SOFA, NOGI DĄB NATURALNY, 140-200	4-6	0,7299	3	DESS. 534	6690
	95-543070563-5-2	SLY SOFA, NOGI DĄB NATURALNY, 140-200	4-6	0,7299	3	DESS. 563	6690
FRODE SOFA							
	742048XXX-11-1-2	FRODE SOFA, NOGI STEM JASNE DREWNO/CZARNY, 140-200	15-17	0,8382	1	DESS. XXX	8210
	742048565-11-1-2	FRODE SOFA, NOGI STEM JASNE DREWNO/CZARNY, 140-200	4-6	0,8382	1	DESS. 565	7120
	742048573-11-1-2	FRODE SOFA, NOGI STEM JASNE DREWNO/CZARNY, 140-200	4-6	0,8382	1	DESS. 573	7120
	742048020XXX-2	FRODE PODŁOKIETNIKI, 1 SET	15-17	0,1209	1	DESS. XXX	1540
	742048020565-2	FRODE PODŁOKIETNIKI, 1 SET	4-6	0,1209	1	DESS. 565	1310
742048020573-2	FRODE PODŁOKIETNIKI, 1 SET	4-6	0,1209	1	DESS. 573	1310	



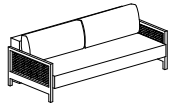
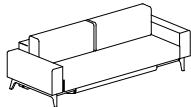

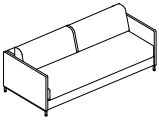
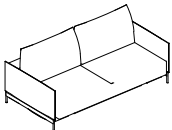
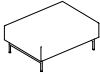
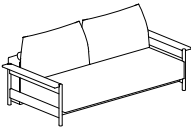
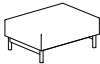

SLYDERS

	NR.ART.	OPIS	TYGODNIE	M3	CLL.	TKANINA	CENA
SLYDERS							
NARVI SOFA (ZE ZDEJMOWANYMI POKROWCAMI)							
	95-725080XXX-1-4-2	NARVI SOFA , NOGI CZARNE DREWNO 140-200	15-17	0,8059	4	DESS. XXX	12080
	95-725080521-1-4-2	NARVI SOFA , NOGI CZARNE DREWNO 140-200	4-6	0,8059	4	DESS. 521	10980
	95-725080577-1-4-2	NARVI SOFA , NOGI CZARNE DREWNO 140-200	4-6	0,8059	4	DESS. 577	10980
	95-725080585-1-4-2	NARVI SOFA , NOGI CZARNE DREWNO 140-200	4-6	0,8059	4	DESS. 585	10980
	725080BXXX	TRYM/NARVI POKROWCE - KOMPLET, 140-200	8-10	0,0485	1	DESS. XXX	1640
TRYM SOFA (ZE ZDEJMOWANYMI POKROWCAMI)							
	95-725080XXX-TRYM	TRYM SOFA, NOGI DĄB, 140-200	15-17	0,7438	4	DESS. XXX	9930
	95-725080521-TRYM	TRYM SOFA, NOGI DĄB, 140-200	4-6	0,7438	4	DESS. 521	8830
	95-725080577-TRYM	TRYM SOFA, NOGI DĄB, 140-200	4-6	0,7438	4	DESS. 577	8830
	95-725080585-TRYM	TRYM SOFA, NOGI DĄB, 140-200	4-6	0,7438	4	DESS. 585	8830
	725080BXXX	TRYM/NARVI POKROWCE - KOMPLET, 140-200	8-10	0,0485	1	DESS. XXX	1640
IDUN SOFA (ZE ZDEJMOWANYMI POKROWCAMI)							
	95-725080XXX-IDUN	IDUN SOFA, NOGI DĄB, 140-200	15-17	0,9147	5	DESS. XXX	12280
	95-725080521-IDUN	IDUN SOFA, NOGI DĄB, 140-200	4-6	0,9147	5	DESS. 521	10990
	95-725080577-IDUN	IDUN SOFA, NOGI DĄB, 140-200	4-6	0,9147	5	DESS. 577	10990
	95-725080585-IDUN	IDUN SOFA, NOGI DĄB, 140-200	4-6	0,9147	5	DESS. 585	10990
	725080020BXXX	IDUN POKROWCE - KOMPLET, 140-200	8-10	0,0485	1	DESS. XXX	2230
ELUMA DELUXE BUTTON SOFA							
	95-745080XXX-5-2	ELUMA DELUXE BUTTON SOFA, NOGI/PODŁOKIETNIKI DĄB, 140-200	15-17	0,8476	4	DESS. XXX	12080
	95-745080565-5-2	ELUMA DELUXE BUTTON SOFA, NOGI/PODŁOKIETNIKI DĄB, 140-200	4-6	0,8476	4	DESS. 565	10980
YONATA SOFA (ZE ZDEJMOWANYMI POKROWCAMI)							
	95-543115XXX-2	YONATA SOFA, NOGI CZARNE METALOWE, 145-200	15-17	1,1100	2	DESS. XXX	10730
	95-543115580-2	YONATA SOFA, NOGI CZARNE METALOWE, 145-200	4-6	1,1100	2	DESS. 580	9350
	95-543115586-2	YONATA SOFA, NOGI CZARNE METALOWE, 145-200	4-6	1,1100	2	DESS. 586	9350
	543115BXXX	YONATA POKROWCE - KOMPLET, 145-200	8-10	0,0265	1	DESS. XXX	1680
SALLA SOFA							
	95-543052XXX-01-2	SALLA SOFA, 140-200	8-10	0,9050	2	DESS. XXX	8940
	95-543052317-01-2	SALLA SOFA, 140-200	4-6	0,9050	2	DESS. 317	7790
	95-543052590-01-2	SALLA SOFA, 140-200	4-6	0,9050	2	DESS. 590	7790

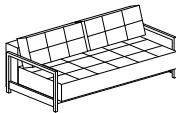
SLYDERS

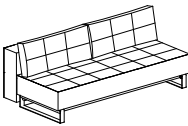
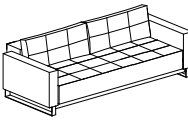
	NR.ART.	OPIS	TYGODNIE	M3	CLL.	TKANINA	CENA
SLYDERS							
NORDHAM SOFA							
	95-728141XXX-01-8-2	NORDHAM SOFA, NOGI STAL NIERDZEWNA, 140-200	15-17	1,0061	4	DESS. XXX	11570
	95-728141528-01-8-2	NORDHAM SOFA, NOGI STAL NIERDZEWNA, 140-200	4-6	1,0061	4	DESS. 528	10060
	95-728141590-01-8-2	NORDHAM SOFA, NOGI STAL NIERDZEWNA, 140-200	4-6	1,0061	4	DESS. 590	10060
MALLOY SOFA (PODŁOKIETNIKI TAPICEROWANE, NOGI METALOWE)							
	95-543125020XXX-2	MALLOY SOFA, NOGI CZARNE METALOWE, 150-200	15-17	1,2540	4	DESS. XXX	12920
	95-543125020533-2	MALLOY SOFA, NOGI CZARNE METALOWE, 150-200	4-6	1,2540	4	DESS. 533	11230
	95-543125020579-2	MALLOY SOFA, NOGI CZARNE METALOWE, 150-200	4-6	1,2540	4	DESS. 579	11230
MALLOY OTTOMAN PUF (NOGI METALOWE)							
	95-543127XXX-2-2	MALLOY OTTOMAN, NOGI CZARNE METALOWE, 75-100	15-17	0,2303	2	DESS. XXX	2710
	95-543127533-2-2	MALLOY OTTOMAN, NOGI CZARNE METALOWE, 75-100	4-6	0,2303	2	DESS. 533	2360
	95-543127579-2-2	MALLOY OTTOMAN, NOGI CZARNE METALOWE, 75-100	4-6	0,2303	2	DESS. 579	2360
MALLOY SOFA (PODŁOKIETNIKI DĘBOWE)							
	95-543125020XXX-5-2	MALLOY SOFA, NOGI/PODŁOKIETNIKI DĄB NATURALNY, 150-200	15-17	1,1931	4	DESS. XXX	13150
	95-543125020533-5-2	MALLOY SOFA, NOGI/PODŁOKIETNIKI DĄB NATURALNY, 150-200	4-6	1,1931	4	DESS. 533	11910
	95-543125020579-5-2	MALLOY SOFA, NOGI/PODŁOKIETNIKI DĄB NATURALNY, 150-200	4-6	1,1931	4	DESS. 579	11910
MALLOY OTTOMAN PUF (NOGI DĘBOWE)							
	95-543127XXX-5-2	MALLOY OTTOMAN, NOGI DĄB NATURALNY, 75-100	15-17	0,2487	2	DESS. XXX	2910
	95-543127533-5-2	MALLOY OTTOMAN, NOGI DĄB NATURALNY, 75-100	4-6	0,2487	2	DESS. 533	2530
	95-543127579-5-2	MALLOY OTTOMAN, NOGI DĄB NATURALNY, 75-100	4-6	0,2487	2	DESS. 579	2530







SLYDERS

	NR.ART.	OPIS	TYGODNIE	M3	CLL.	TKANINA	CENA
SLYDERS							
BIFROST DELUXE E.L. SOFA							
	95-748260XXX-3	BIFROST D.E.L. SOFA, NOGI CZARNE DREWNO, 155-200	15-17	1,0921	4	DESS. XXX	11310
	95-748260528-3	BIFROST D.E.L. SOFA, NOGI CZARNE DREWNO, 155-200	4-6	1,0921	4	DESS. 528	10000
	95-748260563-3	BIFROST D.E.L. SOFA, NOGI CZARNE DREWNO, 155-200	4-6	1,0921	4	DESS. 563	10000
	95-748260587-3	BIFROST D.E.L. SOFA, NOGI CZARNE DREWNO, 155-200	4-6	1,0921	4	DESS. 587	10000
BIFROST OTTOMAN							
	95-748251XXX-3	BIFROST OTTOMAN, NOGI CZARNE DREWNO, 65-65	15-17	0,1476	2	DESS. XXX	2570
	95-748251528-3	BIFROST OTTOMAN, NOGI CZARNE DREWNO, 65-65	4-6	0,1476	2	DESS. 528	2320
	95-748251563-3	BIFROST OTTOMAN, NOGI CZARNE DREWNO, 65-65	4-6	0,1476	2	DESS. 563	2320
	95-748251587-3	BIFROST OTTOMAN, NOGI CZARNE DREWNO, 65-65	4-6	0,1476	2	DESS. 587	2320
SUPREMAX DELUXE E.L. SOFA							
	95-748260XXX-0-2	SUPREMAX D.E.L. SOFA, NOGI CHROM, 155-200	15-17	1,0475	3	DESS. XXX	10060
	95-748260528-0-2	SUPREMAX D.E.L. SOFA, NOGI CHROM, 155-200	4-6	1,0475	3	DESS. 528	8750
	95-748260563-0-2	SUPREMAX D.E.L. SOFA, NOGI CHROM, 155-200	4-6	1,0475	3	DESS. 563	8750
	95-748260587-0-2	SUPREMAX D.E.L. SOFA, NOGI CHROM, 155-200	4-6	1,0475	3	DESS. 587	8750
SUPREMAX OTTOMAN							
	95-748251XXX-0	DELUXE EXCESS OTTOMAN PUF, NOGI CHROM, 65-65	15-17	0,1454	2	DESS. XXX	2370
	95-748251528-0	DELUXE EXCESS OTTOMAN PUF, NOGI CHROM, 65-65	4-6	0,1454	2	DESS. 528	2120
	95-748251563-0	DELUXE EXCESS OTTOMAN PUF, NOGI CHROM, 65-65	4-6	0,1454	2	DESS. 563	2120
	95-748251587-0	DELUXE EXCESS OTTOMAN PUF, NOGI CHROM, 65-65	4-6	0,1454	2	DESS. 587	2120
CASSIUS DELUXE E.L. SOFA							
	95-748282XXX-0-2	CASSIUS D.E.L. SOFA, NOGI CHROM, 155-200	15-17	1,2949	4	DESS. XXX	13350
	95-748282528-0-2	CASSIUS D.E.L. SOFA, NOGI CHROM, 155-200	4-6	1,2949	4	DESS. 528	11730
	95-748282563-0-2	CASSIUS D.E.L. SOFA, NOGI CHROM, 155-200	4-6	1,2949	4	DESS. 563	11730
	95-748282587-0-2	CASSIUS D.E.L. SOFA, NOGI CHROM, 155-200	4-6	1,2949	4	DESS. 587	11730
CASSIUS OTTOMAN							
	95-748251XXX-0	DELUXE EXCESS OTTOMAN, NOGI CHROM, 65-65	15-17	0,1454	2	DESS. XXX	2370
	95-748251528-0	DELUXE EXCESS OTTOMAN, NOGI CHROM, 65-65	4-6	0,1454	2	DESS. 528	2120
	95-748251563-0	DELUXE EXCESS OTTOMAN, NOGI CHROM, 65-65	4-6	0,1454	2	DESS. 563	2120
	95-748251587-0	DELUXE EXCESS OTTOMAN, NOGI CHROM, 65-65	4-6	0,1454	2	DESS. 587	2120
PYXIS DELUXE E.L. SOFA							
	95-748285XXX-5-2	PYXIS DELUXE E.L. SOFA, NOGI DĄB NATURALNY, 155-200	15-17	1,2298	5	DESS. XXX	12850
	95-748285528-5-2	PYXIS DELUXE E.L. SOFA, NOGI DĄB NATURALNY, 155-200	4-6	1,2298	5	DESS. 528	11170
	95-748285563-5-2	PYXIS DELUXE E.L. SOFA, NOGI DĄB NATURALNY, 155-200	4-6	1,2298	5	DESS. 563	11170
	95-748285587-5-2	PYXIS DELUXE E.L. SOFA, NOGI DĄB NATURALNY, 155-200	4-6	1,2298	5	DESS. 587	11170
PYXIS OTTOMAN							
	95-748251XXX-5-2	PYXIS EXCESS OTTOMAN, NOGI DĄB NATURALNY, 65-65	15-17	0,1520	3	DESS. XXX	2660
	95-748251528-5-2	PYXIS EXCESS OTTOMAN, NOGI DĄB NATURALNY, 65-65	4-6	0,1520	3	DESS. 528	2290
	95-748251563-5-2	PYXIS EXCESS OTTOMAN, NOGI DĄB NATURALNY, 65-65	4-6	0,1520	3	DESS. 563	2290
	95-748251587-5-2	PYXIS EXCESS OTTOMAN, NOGI DĄB NATURALNY, 65-65	4-6	0,1520	3	DESS. 587	2290

SLYDERS

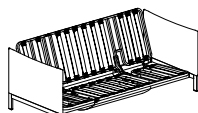
	NR.ART.	OPIS	TYGODNIE	M3	CLL.	TKANINA	CENA
SLYDERS							
BRAGI SOFA, 2 PODŁOKIETNIKI, (MOŻNA ZMONTOWAĆ JAKO PRAWA LUB LEWA)							
	95-725031XXX-2-2	BRAGI SOFA + 2 PODŁOKIETNIKI, NOGI METAL. CZARNE, 140-200	15-17	1,2530	6	DESS. XXX	13290
	95-725031217-2-2	BRAGI SOFA + 2 PODŁOKIETNIKI, NOGI METAL. CZARNE, 140-200	4-6	1,2530	6	DESS. 217	11910
BRAGI SOFA, 1 PODŁOKIETNIK + STOLIK DĘBOWY, (MOŻNA ZMONTOWAĆ JAKO PRAWA LUB LEWA)							
	95-725031XXX-5-2	BRAGI SOFA, 1 PODŁOKIETNIK + STOLIK DĘBOWY, 140-200	15-17	1,2113	6	DESS. XXX	13050
	95-725031217-5-2	BRAGI SOFA, 1 PODŁOKIETNIK + STOLIK DĘBOWY, 140-200	4-6	1,2113	6	DESS. 217	11800
VOGAN SOFA (MOŻNA ZMONTOWAĆ JAKO PRAWA LUB LEWA)							
	95-728296XXX-4-2	VOGAN SOFA, CZARNY STOLIK/PÓŁKA, 120-200	15-17	1,6951	5	DESS. XXX	13970
	95-728296521-4-2	VOGAN SOFA, CZARNY STOLIK/PÓŁKA, 120-200	4-6	1,6951	5	DESS. 521	12170
	95-728296577-4-2	VOGAN SOFA, CZARNY STOLIK/PÓŁKA, 120-200	4-6	1,6951	5	DESS. 577	12170
VOGAN LOUNGER (MOŻNA ZMONTOWAĆ JAKO PRAWA LUB LEWA)							
	95-728296XXX-LOUN	VOGAN LOUNGER, CZARNY STOLIK/PÓŁKA, 120-200	15-17	1,8468	5	DESS. XXX	14460
	95-728296521-LOUN	VOGAN LOUNGER, CZARNY STOLIK/PÓŁKA, 120-200	4-6	1,8468	5	DESS. 521	12610
	95-728296577-LOUN	VOGAN LOUNGER, CZARNY STOLIK/PÓŁKA, 120-200	4-6	1,8468	5	DESS. 577	12610
OSVALD SOFA							
	95-543091XXX-2	OSVALD SOFA, CZARNY MAT, 150-200	8-10	1,1514	2	DESS. XXX	10260
	95-543091318-2	OSVALD SOFA, CZARNY MAT, 150-200	4-6	1,1514	2	DESS. 318	8950
	95-543091565-2	OSVALD SOFA, CZARNY MAT, 150-200	4-6	1,1514	2	DESS. 565	8950
	95-543091580-2	OSVALD SOFA, CZARNY MAT, 150-200	4-6	1,1514	2	DESS. 580	8950
TRIFI SOFA							
	95-543091020XXX-01-2	TRIFI SOFA, CZARNY MAT, 150-200	8-10	1,3265	3	DESS. XXX	12420
	95-543091020318-01-2	TRIFI SOFA, CZARNY MAT, 150-200	4-6	1,3265	3	DESS. 318	10730
	95-543091020565-01-2	TRIFI SOFA, CZARNY MAT, 150-200	4-6	1,3265	3	DESS. 565	10730
	95-543091020580-01-2	TRIFI SOFA, CZARNY MAT, 150-200	4-6	1,3265	3	DESS. 580	10730
CORNILA OTTOMAN PUF							
	543062XXX	CORNILA OTTOMAN, 75-75	8-10	0,2896	1	DESS. XXX	3070
	543062318	CORNILA OTTOMAN, 75-75	4-6	0,2896	1	DESS. 318	2600
	543062565	CORNILA OTTOMAN, 75-75	4-6	0,2896	1	DESS. 565	2600
	543062580	CORNILA OTTOMAN, 75-75	4-6	0,2896	1	DESS. 580	2600

SOFY WIELOFUNKCYJNE – ZAPROJEKTUJ SAM

	NR.ART.	OPIS	TYGODNIE	M3	CLL	TKANINA	CENA
STELAŻE 140-200, Z REGULOWANYM WEZGŁOWIEM							
ASLAK STELAŻ							
	528014140-5-2	ASLAK STELAŻ, DĄB NATURALNY/CZARNY MAT, 140-200	4-6	0,1395	2		3170
BALDER STELAŻ							
	528024140-5-2	BALDER STELAŻ, DĄB NATURALNY/CZARNY MAT, 140-200	4-6	0,2522	2		4040
MIMER STELAŻ							
	528026140XXX-5-2	MIMER STELAŻ, DĄB NATURALNY/CZARNY MAT, 140-200	4-6	0,3116	3	DESS. XXX	4040
JUNUS STELAŻ							
	528028140XXX-2	JUNUS STELAŻ, CZARNY MAT, 140-200	4-6	0,3417	3	DESS. XXX	4040
COLPUS STELAŻ							
	528004140-10-1-2	COLPUS STELAŻ, JASNE DREWNO/CZARNY MAT, 140-200	4-6	0,1251	2		2640
	528004140-10-4-2	COLPUS STELAŻ, CZARNE DREWNO/CZARNY MAT, 140-200	4-6	0,1251	2		2640
MINIMUM STELAŻ							
	528022140-0-2	MINIMUM STELAŻ, CHROM/CZARNY MAT, 140-200	4-6	0,1380	1		2640
FRACTION STELAŻ							
	528017140-2-2	FRACTION STELAŻ, CZARNY MAT, 140-200	4-6	0,1366	2		2360

SOFY WIELOFUNKCYJNE – ZAPROJEKTUJ SAM

NR.ART.	OPIS	TYGODNIE	M3	CLL.	TKANINA	CENA
---------	------	----------	----	------	---------	------

MATERACE, 140-200

WHITE MATERAC, TKANINA TECHNICZNA – KONIECZNY JEST DODATKOWO POKROWIEC, 140-200

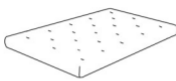
	1540200	CLASSIC MATERAC, 140-200	4-6	0,3640	1	DESS. 200	1640
	1640200	SPRING MATERAC, 140-200	4-6	0,4200	1	DESS. 200	2940
	1469200+	SOFT SPRING MATERAC, 140-200	4-6	0,4760	1	DESS. 200	3290
	1740200	LATEX MATERAC, 140-200	4-6	0,3780	1	DESS. 200	3660

MATERAC OTAPICEROWANY WYBRANĄ TKANINĄ – NA STAŁE, 140-200 – POKROWIEC NIE JEST KONIECZNY

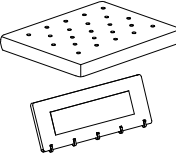
	1543XXX	CLASSIC NORDIC MATERAC + POKROWIEC NA OPARCIE STELAŻA, 140-200	4-6	0,3640	1	DESS. XXX	2230
	1643XXX	SPRING NORDIC MATERAC + POKROWIEC NA OPARCIE STELAŻA, 140-200	4-6	0,4200	1	DESS. XXX	4010
	1843XXX	SOFT SPRING NORDIC MATERAC + POKR. NA OPARCIE STELAŻA, 140-200	4-6	0,4760	1	DESS. XXX	4350
	1743XXX	LATEX NORDIC MATERAC + POKROWIEC NA OPARCIE STELAŻA, 140-200	4-6	0,3780	1	DESS. XXX	4710

POKROWCE, 140-200

POKROWIEC NA MATERAC, 140-200 + POKROWIEC NA OPARCIE STELAŻA

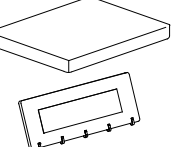
	563140XXX	NORDIC POKROWIEC + POKR. NA OPARCIE STELAŻA, 140-200	4-6	0,0250	1	DESS. XXX	1550
	577140XXX	SHARP PLUS POKROWIEC + POKR. NA OPARCIE STELAŻA, 140-200	4-6	0,0250	1	DESS. XXX	1550





POKROWIEC NA CZĘŚĆ SIEDZISKOWĄ STELAŻA, 140-200

	528140XXX-01	POKROWIEC NA SIEDZISKO, 140-200	4-6	0,0084	1	DESS. XXX	860
---	--------------	---------------------------------	-----	--------	---	-----------	-----



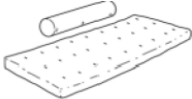

SOFY WIELOFUNKCYJNE – ZAPROJEKTUJ SAM

	NR.ART.	OPIS	TYGODNIE	M3	CLL.	TKANINA	CENA
STELAŻE, 120-200 - Z REGULOWANYM WEZGŁOWIEM							
ASLAK STELAŻ							
	528014120-5-2	ASLAK STELAŻ, DĄB NATURALNY/CZARNY MAT, 120-200	4-6	0,1242	2		2810
FRACTION STELAŻ							
	528017120-2-2	FRACTION STELAŻ, CZARNY MAT, 120-200	4-6	0,1243	2		2000
MATERACE, 120-200							
WHITE MATERAC, 120-200, TKANINA TECHNICZNA – KONIECZNY JEST DODATKOWO POKROWIEC, 120-200							
	1520200	CLASSIC MATERAC, 120-200	4-6	0,2880	1	DESS. 200	1520
	1620200	SPRING MATERAC, 120-200	4-6	0,3100	1	DESS. 200	2170
	1269200+	SOFT SPRING MATERAC, 120-200	4-6	0,3600	1	DESS. 200	2810
MATERAC OTAPICEROWANY WYBRANĄ TKANINĄ – NA STAŁE, 120-200, POKROWIEC NIE JEST KONIECZNY							
	1523XXX	CLASSIC NORDIC MATERAC + POKROWIEC NA OPARCIE STELAŻA, 120-200	4-6	0,2880	1	DESS. XXX	1940
	1623XXX	SPRING NORDIC MATERAC + POKROWIEC NA OPARCIE STELAŻA, 120-200	4-6	0,3100	1	DESS. XXX	3150
	1823XXX	SOFT SPRING NORDIC MATERAC + POKR. NA OPARCIE STELAŻA, 120-200	4-6	0,3600	1	DESS. XXX	3730
POKROWCE, 120-200							
POKROWIEC NA MATERAC, 120-200 + POKROWIEC NA OPARCIE STELAŻA							
	563120XXX	NORDIC POKROWIEC + POKROWIEC NA OPARCIE STELAŻA, 120-200	4-6	0,0230	1	DESS. XXX	1460
	577120XXX	SHARP PLUS POKROWIEC + POKROWIEC NA OPARCIE STELAŻA, 120-200	4-6	0,0230	1	DESS. XXX	1460
POKROWIEC NA CZĘŚĆ SIEDZISKOWĄ STELAŻA, 120-200							
	528120XXX-01	FRACTION & ASLAK POKROWIEC NA SIEDZISKO STELAŻA, 120-200	4-6	0,0078	1	DESS. XXX	740

SOFY WIELOFUNKCYJNE – ZAPROJEKTUJ SAM

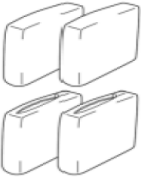
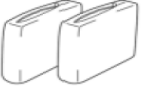
	NR.ART.	OPIS	TYGODNIE	M3	CLL.	TKANINA	CENA
STELAŻE 80-200 - REGULOWANE							
ROLLO STYLETTO STELAŻ							
	495080-10-3-2	ROLLO STYLETTO STELAŻ CIEMNE DREWNO/CZARNY MAT, 80-200	4-6	0,0612	2		1160
ROLLO STEM STELAŻ							
	495080-11-1-2	ROLLO STEM STELAŻ, JASNE DREWNO/CZARNY MAT, 80-200	4-6	0,0624	2		1160
ROLLO BOW STELAŻ							
	495080-12-5-2	ROLLO BOW STELAŻ, DĄB NATURALNY/CZARNY MAT, 80-200	4-6	0,0625	2		1160
MATERAC Z WAŁKIEM, 80-200							
WHITE MATERAC Z WAŁKIEM, 80-200 - TKANINA TECHNICZNA – KONIECZNY JEST DODATKOWO POKROWIEC							
	1508200	ROLLO CLASSIC MATERAC Z WAŁKIEM, 80-200	4-6	0,1820	2	DESS. 200	1530
	1608200	ROLLO SPRING MATERAC Z WAŁKIEM, 80-200	4-6	0,2080	2	DESS. 200	2190
MATERAC Z WAŁKIEM OTAPICEROWANY WYBRANĄ TKANINĄ, 80-200, POKROWIEC NIE JEST KONIECZNY							
	1508XXX	ROLLO CLASSIC ROUND MATERAC Z WAŁKIEM, 80-200	4-6	0,1820	2	DESS. XXX	1750
	1608XXX	ROLLO SPRING ROUND MATERAC Z WAŁKIEM, 80-200	4-6	0,2080	2	DESS. XXX	2320

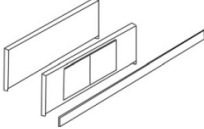

SOFY WIELOFUNKCYJNE – ZAPROJEKTUJ SAM

	NR.ART.	OPIS	TYGODNIE	M3	CLL.	TKANINA	CENA
ROLLO SQUARE PODUSZKI							
PODUSZKI SQUARE/POKROWCE NA PODUSZKI SQUARE							
	405AXXX	SQUARE PODUSZKI KOMPLETNE, 50-50-11, 1 SET	4-6	0,0700	1	DESS. XXX	820
	405BXXX	SQUARE POKROWCE NA PODUSZKI, 1 SET	4-6	0,0103	1	DESS. XXX	510
POKROWCE, 80-200							
POKROWIEC NA MATERAC ROLLO, 80-200							
	495080XXX	ROLLO ROUND POKROWIEC NA MATERAC, 80-200	4-6	0,0080	1	DESS. XXX	850
KOMPLETNY POKROWIEC NA STELAŻ ROLLO, 80-200							
	495001XXX	ROLLO POKROWIEC NA STELAŻ, 80-200	4-6	0,0055	1	DESS. XXX	730
POKROWIEC NA WAŁEK ROLLO							
	495080XXX-02	POKROWIEC NA WAŁEK ROLLO	4-6	0,0018	1	DESS. XXX	300



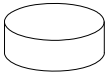
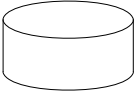
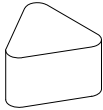

DODATKI





	NR.ART.	OPIS	TYGODNIE	M3	CLL.	TKANINA	CENA
PODUSZKI I POKROWCE NA PODUSZKI							
PODUSZKI ROLL/POKROWCE NA PODUSZKI ROLL							
	411AXXX	ROLL PODUSZKI KOMPLETNE, Ø25-55, 1 SET	4-6	0,0700	1	DESS. XXX	500
	411BXXX	ROLL POKROWCE NA PODUSZKI, 1 SET	4-6	0,0040	1	DESS. XXX	370
PODUSZKI ELLIPSE/POKROWCE NA PODUSZKI ELLIPSE							
	481012AXXX	ELLIPSE PODUSZKI KOMPLETNE, 55-25-13, 1 SET	4-6	0,0200	1	DESS. XXX	500
	481012BXXX	ELLIPSE POKROWCE NA PODUSZKI, 1 SET	4-6	0,0038	1	DESS. XXX	370
PODUSZKA DAPPER 50-50/POKROWIEC NA PODUSZKĘ							
	406AXXX	DAPPER PODUSZKA KOMPLETNA, 50-50, 1 PCS.	4-6	0,0162	1	DESS. XXX	310
	406BXXX	DAPPER POKROWIEC NA PODUSZKĘ 50-50, 1 PCS.	4-6	0,0022	1	DESS. XXX	260
PODUSZKA DAPPER 65-65/POKROWIEC NA PODUSZKĘ							
	406065AXXX	DAPPER PODUSZKA KOMPLETNA, 65-65, 1 PCS.	4-6	0,0430	1	DESS. XXX	400
	406065BXXX	DAPPER POKROWIEC NA PODUSZKĘ 65-65, 1 PCS.	4-6	0,0038	1	DESS. XXX	320
PODUSZKA DAPPER 40-60/POKROWIEC NA PODUSZKĘ							
	406060AXXX	DAPPER PODUSZKA KOMPLETNA, 40-60, 1 PCS.	4-6	0,0288	1	DESS. XXX	350
	406060BXXX	DAPPER POKROWIEC NA PODUSZKĘ 40-60, 1 PCS.	4-6	0,0058	1	DESS. XXX	280
PODUSZKA DAPPER 50-80/POKROWIEC NA PODUSZKĘ							
	406080AXXX	DAPPER PODUSZKA KOMPLETNA, 50-80, 1 PCS.	4-6	0,0400	1	DESS. XXX	500
	406080BXXX	DAPPER POKROWIEC NA PODUSZKĘ 50-80, 1 PCS.	4-6	0,0058	1	DESS. XXX	410
PODUSZKA CIRCLE, Ø40 CM & Ø45 CM							
	404040XXX	CIRCLE PODUSZKA Ø40 CM, 1 PCS.	4-6	0,0134	1	DESS. XXX	190
	404045XXX	CIRCLE PODUSZKA Ø45 CM, 1 PCS.	4-6	0,0190	1	DESS. XXX	230

DODATKI

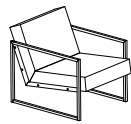
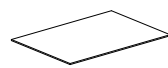
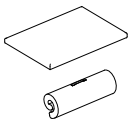



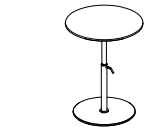

	NR.ART.	OPIS	TYGODNIE	M3	CLL.	TKANINA	CENA
RUCHOMY ZAGŁÓWEK, CZARNY							
	725048XXX-11	FLIP RUCHOMY ZAGŁÓWEK, CZARNY STELAŻ, 25-60 PASUJE DO: SLY, RECAST, ACHILLAS, FRODE, ELUMA, NARVI, NORDHAM, TRYM, IDUN, BRAGI, TRIPI, OSVALD, CONLIX, SUPREMAX, BIFROST, CASSIUS, CUBED, MERGA, COSIAL & PYXIS	4-6	0,0350	2	DESS. XXX	940
PAUKE 50/POKROWIEC PAUKE 50							
	554AXXX 554A316 554A318 554A533 554A565 554A573 554A575 554BXXX	PAUKE 50, Ø50-20 PAUKE 50, Ø50-20 PAUKE 50, Ø50-20 PAUKE 50, Ø50-20 PAUKE 50, Ø50-20 PAUKE 50, Ø50-20 PAUKE 50, Ø50-20 PAUKE 50, Ø50-20 PAUKE 50 POKROWIEC, Ø50-20	8-10 4-6 4-6 4-6 4-6 4-6 4-6 8-10	0,0480 0,0480 0,0480 0,0480 0,0480 0,0480 0,0480 0,0103	1 1 1 1 1 1 1 1	DESS. XXX DESS. 316 DESS. 318 DESS. 533 DESS. 565 DESS. 573 DESS. 575 DESS. XXX	650 650 650 650 650 650 650 340
PAUKE 62/POKROWIEC PAUKE 62							
	554001AXXX 554001A316 554001A318 554001A533 554001A565 554001A573 554001A575 554001BXXX	PAUKE 62, Ø62-40 PAUKE 62, Ø62-40 PAUKE 62, Ø62-40 PAUKE 62, Ø62-40 PAUKE 62, Ø62-40 PAUKE 62, Ø62-40 PAUKE 62, Ø62-40 PAUKE 62, Ø62-40 PAUKE 62 POKROWIEC, Ø62-40	8-10 4-6 4-6 4-6 4-6 4-6 4-6 8-10	0,1500 0,1500 0,1500 0,1500 0,1500 0,1500 0,1500 0,0103	1 1 1 1 1 1 1 1	DESS. XXX DESS. 316 DESS. 318 DESS. 533 DESS. 565 DESS. 573 DESS. 575 DESS. XXX	1020 1020 1020 1020 1020 1020 1020 560
TRIANGULAR/POKROWIEC TRIANGULAR							
	554002AXXX 554002A316 554002A318 554002A533 554002A565 554002A573 554002A575 554002BXXX	TRIANGULAR, 60-38 TRIANGULAR, 60-38 TRIANGULAR, 60-38 TRIANGULAR, 60-38 TRIANGULAR, 60-38 TRIANGULAR, 60-38 TRIANGULAR, 60-38 TRIANGULAR, 60-38 TRIANGULAR POKROWIEC, 60-38	8-10 4-6 4-6 4-6 4-6 4-6 4-6 8-10	0,0700 0,0700 0,0700 0,0700 0,0700 0,0700 0,0700 0,0103	1 1 1 1 1 1 1 1	DESS. XXX DESS. 316 DESS. 318 DESS. 533 DESS. 565 DESS. 573 DESS. 575 DESS. XXX	930 930 930 930 930 930 930 510
ACCORDION 75/POKROWIEC ACCORDION 75							
	554004AXXX 554004A316 554004A318 554004A533 554004A565 554004A573 554004A575 554004BXXX	ACCORDION 75 MATERAC, 75-150-40 ACCORDION 75 MATERAC, 75-150-40 ACCORDION 75 MATERAC, 75-150-40 ACCORDION 75 MATERAC, 75-150-40 ACCORDION 75 MATERAC, 75-150-40 ACCORDION 75 MATERAC, 75-150-40 ACCORDION 75 MATERAC, 75-150-40 ACCORDION 75 MATERAC, 75-150-40 ACCORDION 75 POKROWIEC NA MATERAC, 75-150	8-10 4-6 4-6 4-6 4-6 4-6 4-6 8-10	0,1491 0,1491 0,1491 0,1491 0,1491 0,1491 0,1491 0,0114	1 1 1 1 1 1 1 1	DESS. XXX DESS. 316 DESS. 318 DESS. 533 DESS. 565 DESS. 573 DESS. 575 DESS. XXX	1460 1270 1270 1270 1270 1270 1270 560
ACCORDION 150/POKROWIEC ACCORDION 150							
	554003AXXX 554003A316 554003A318 554003A533 554003A565 554003A573 554003A575 554003BXXX	ACCORDION 150 MATERAC, 150-150-40 ACCORDION 150 MATERAC, 150-150-40 ACCORDION 150 MATERAC, 150-150-40 ACCORDION 150 MATERAC, 150-150-40 ACCORDION 150 MATERAC, 150-150-40 ACCORDION 150 MATERAC, 150-150-40 ACCORDION 150 MATERAC, 150-150-40 ACCORDION 150 MATERAC, 150-150-40 ACCORDION 150 POKROWIEC NA MATERAC, 150-150	8-10 4-6 4-6 4-6 4-6 4-6 4-6 8-10	0,2973 0,2973 0,2973 0,2973 0,2973 0,2973 0,2973 0,0228	1 1 1 1 1 1 1 1	DESS. XXX DESS. 316 DESS. 318 DESS. 533 DESS. 565 DESS. 573 DESS. 575 DESS. XXX	2710 2360 2360 2360 2360 2360 2360 930

DODATKI

	NR.ART.	OPIS	TYGODNIE	M3	CLL.	TKANINA	CENA
SOFT PEAK BEANBAG/SOFT PEAK POKROWIEC							
	429046AXXX	SOFT PEAK BEANBAG KOMPLETNY, 105-135-80	4-6	0,3300	1	DESS. XXX	1230
	429046BXXX	SOFT PEAK BEANBAG POKROWIEC	4-6	0,0103	1	DESS. XXX	660
BUTT BEANBAG/BUTT POKROWIEC							
	425015AXXX	BUTT BEANBAG KOMPLETNY, Ø45-50	4-6	0,1000	1	DESS. XXX	600
	425015BXXX	BUTT BEANBAG POKROWIEC	4-6	0,0103	1	DESS. XXX	330
VIKKO FOTEL							
	555XXX-2	VIKKO FOTEL, CZARNE NOGI METAL, 62-69	8-10	0,1166	1	DESS. XXX	1800
	555507-2	VIKKO FOTEL, CZARNE NOGI METAL, 62-69	4-6	0,1166	1	DESS. 507	1560
	555534-2	VIKKO FOTEL, CZARNE NOGI METAL, 62-69	4-6	0,1166	1	DESS. 534	1560
	555565-2	VIKKO FOTEL, CZARNE NOGI METAL, 62-69	4-6	0,1166	1	DESS. 565	1560
	555573-2	VIKKO FOTEL, CZARNE NOGI METAL, 62-69	4-6	0,1166	1	DESS. 573	1560
	555584-2	VIKKO FOTEL, CZARNE NOGI METAL, 62-69	4-6	0,1166	1	DESS. 584	1560
	555595-2	VIKKO FOTEL, CZARNE NOGI METAL, 62-69	4-6	0,1166	1	DESS. 595	1560
VIKKO FOTEL Z PODŁOKIETNIKAMI							
	555020XXX-2	VIKKO FOTEL, Z PODŁ.,NOGI/PODŁOKIETNIKI CZARNY METAL, 62-69	8-10	0,1166	1	DESS. XXX	2080
	555020507-2	VIKKO FOTEL, Z PODŁ.,NOGI/PODŁOKIETNIKI CZARNY METAL, 62-69	4-6	0,1166	1	DESS. 507	1820
	555020534-2	VIKKO FOTEL, Z PODŁ.,NOGI/PODŁOKIETNIKI CZARNY METAL, 62-69	4-6	0,1166	1	DESS. 534	1820
	555020565-2	VIKKO FOTEL, Z PODŁ.,NOGI/PODŁOKIETNIKI CZARNY METAL, 62-69	4-6	0,1166	1	DESS. 565	1820
	555020573-2	VIKKO FOTEL, Z PODŁ.,NOGI/PODŁOKIETNIKI CZARNY METAL, 62-69	4-6	0,1166	1	DESS. 573	1820
	555020584-2	VIKKO FOTEL, Z PODŁ.,NOGI/PODŁOKIETNIKI CZARNY METAL, 62-69	4-6	0,1166	1	DESS. 584	1820
	555020595-2	VIKKO FOTEL, Z PODŁ.,NOGI/PODŁOKIETNIKI CZARNY METAL, 62-69	4-6	0,1166	1	DESS. 595	1820
MATTRESS PAD – POKROWIEC OCHRONNY							
	142080	MATTRESS PAD, 80-200-1	4-6	0,0120	1		190
	142090	MATTRESS PAD, 90-200-1	4-6	0,0120	1		210
	142120	MATTRESS PAD, 120-200-1	4-6	0,0120	1		280
	142140	MATTRESS PAD, 140-200-1	4-6	0,0192	1		310
	142150	MATTRESS PAD, 150-200-1	4-6	0,0208	1		330
	142160	MATTRESS PAD, 160-200-1	4-6	0,0225	1		340
INNO TOPPER – MATERAC NAWIERZCHNIOWY 120-200, 140-200, 150-200 & 160-200 CM							
	14120	INNO TOPPER 120-200-5 + TORBA	4-6	0,0375	1		1090
	14140	INNO TOPPER 140-200-5 + TORBA	4-6	0,0438	1		1270
	14150	INNO TOPPER 150-200-5 +TORBA	4-6	0,0469	1		1350
	14160	INNO TOPPER 160-200-5 + TORBA	4-6	0,0500	1		1450

	NR.ART.	OPIS	TYGODNIE	M3	CLL.	TKANINA	CENA
TACE I STOŁY							
GRIDS STOLIK							
	95-760230206-4-11	GRIDS STOLIK, Ø35 CM, H:25 CM, CZARNE DREWNO/CZARNY	4-6	0,0260	2		700
	95-760230206-5-11	GRIDS STOLIK, Ø35 CM, H:25 CM, DĄB/CZARNY	4-6	0,0260	2		700
	95-760231207-4-11	GRIDS STOLIK, Ø45 CM, H:32,5 CM, CZARNE DREWNO/CZARNY	4-6	0,0502	2		930
	95-760231207-5-11	GRIDS STOLIK, Ø45 CM, H:32,5 CM, DĄB/CZARNY	4-6	0,0502	2		930
	95-760232208-4-11	GRIDS STOLIK, Ø70 CM, H:40 CM, CZARNE DREWNO/CZARNY	4-6	0,1212	2		1480
	95-760232208-5-11	GRIDS STOLIK, Ø70 CM, H:40 CM, DĄB/CZARNY	4-6	0,1212	2		1480
STYLO STOLIK							
	95-760230224-4-3	STYLO STOLIK, Ø35 CM, H:32,5 CM, CZARNE DR./CIEMNE DREWNO	4-6	0,0152	2		850
	95-760231224-4-3	STYLO STOLIK, Ø45 CM, H:32,5 CM, CZARNE DR./CIEMNE DREWNO	4-6	0,0195	2		930
	95-760232223-4-3	STYLO STOLIK, Ø70 CM, H:40 CM, CZARNE DR./CIEMNE DREWNO	4-6	0,0481	2		1480
NORDIC STOLIK							
	95-760230226-4-5	NORDIC STOLIK Ø35 CM, H:32,5 CM, CZARNE DREWNO/DĄB	4-6	0,0152	2		850
	95-760230226-5-5	NORDIC STOLIK Ø35 CM, H:32,5 CM, DĄB/DĄB	4-6	0,0152	2		850
	95-760231226-4-5	NORDIC STOLIK Ø45 CM, H:32,5 CM, CZARNE DREWNO/DĄB	4-6	0,0195	2		930
	95-760231226-5-5	NORDIC STOLIK Ø45 CM, H:32,5 CM, DĄB/DĄB	4-6	0,0195	2		930
	95-760232225-4-5	NORDIC STOLIK Ø70 CM, H:40 CM, CZARNE DREWNO/DĄB	4-6	0,0483	2		1480
95-760232225-5-5	NORDIC STOLIK Ø70 CM, H:40 CM, DĄB/DĄB	4-6	0,0483	2		1480	
LASER STOLIK							
	95-760230228-4-2	LASER STOLIK Ø35, H:32,5 CM, CZARNE DREWNO/CZARNY	4-6	0,0209	2		1030
	95-760230228-5-2	LASER STOLIK Ø35, H:32,5 CM, DĄB/CZARNY	4-6	0,0209	2		1030
	95-760231228-4-2	LASER STOLIK Ø45, H:32,5 CM, CZARNE DREWNO/CZARNY	4-6	0,0252	2		1110
	95-760231228-5-2	LASER STOLIK Ø45, H:32,5 CM, DĄB/CZARNY	4-6	0,0252	2		1110
	95-760232227-4-2	LASER STOLIK Ø70, H:40 CM, CZARNE DREWNO/CZARNY	4-6	0,0551	2		1720
	95-760232227-5-2	LASER STOLIK Ø70, H:40 CM, DĄB/CZARNY	4-6	0,0551	2		1720
MARBLE STOLIK							
	95-760229228-35-2	MARBLE STOLIK Ø35, H:32,5 CM, BIAŁY MARMUR/CZARNY	4-6	0,0393	2		1750
	95-760229228-45-2	MARBLE STOLIK Ø45, H:32,5 CM, BIAŁY MARMUR/CZARNY	4-6	0,0525	2		2190
	95-760229227-70-2	MARBLE STOLIK Ø70, H:40 CM, BIAŁY MARMUR/CZARNY	4-6	0,0980	2		2640
KIFFA STOLIK							
	95-760231233-4-2	KIFFA STOLIK Ø45, H:40-68 CM, CZARNY DĄB/CZARNY	4-6	0,0311	2		1450
	95-760231233-5-2	KIFFA STOLIK Ø45, H:40-68 CM, DĄB/CZARNY	4-6	0,0311	2		1450

DODATKI

	NR.ART.	OPIS	TYGODNIE	M3	CLL.	TKANINA	CENA
TRAY/BLAT/NOGI							
	760230-4	TRAY BLAT, Ø35, CZARNE DREWNO	4-6	0,0116	1		330
	760230-5	TRAY BLAT, Ø35, DĄB NATURALNY LAKIEROWANY	4-6	0,0116	1		330
	760229-035	TRAY BLAT, Ø35, BIAŁY MARMUR	4-6	0,0300	1		1050
	760231-4	TRAY BLAT, Ø45, CZARNE DREWNO	4-6	0,0159	1		410
	760231-5	TRAY BLAT, Ø45, DĄB NATURALNY LAKIEROWANY	4-6	0,0159	1		410
	760229-045	TRAY BLAT, Ø45, BIAŁY MARMUR	4-6	0,0432	1		1490
	760234-6	TRAY BLAT, Ø70, CZARNE DREWNO	4-6	0,0438	1		820
	760232-5	TRAY BLAT, Ø70, DĄB NATURALNY LAKIEROWANY	4-6	0,0438	1		820
	760229-070	TRAY BLAT, Ø70, BIAŁY MARMUR	4-6	0,0867	1		1740
	760224-3	STYLO NOGI, CIEMNE DREWNO, H:32,5 CM, 3 PCS.	4-6	0,0036	1		520
	760223-3	STYLO NOGI, CIEMNE DREWNO, H:40 CM, 3 PCS.	4-6	0,0043	1		660
	760226-5	NORDIC NOGI, DĄB, H:32,5 CM, 3 PCS.	4-6	0,0036	1		520
	760225-5	NORDIC NOGI, DĄB, H:40 CM, 3 PCS.	4-6	0,0045	1		660
	760228-2	LASER NOGI, CZARNE, H:32,5 CM, 3 PCS.	4-6	0,0093	1		700
	760227-2	LASER NOGI, CZARNE, H:40 CM, 3 PCS.	4-6	0,0113	1		900

STORAGE STOLIK, Ø70 CM, CZARNY DĄB

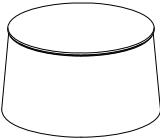
	95-760238XXX-4	STORAGE, BLAT STOLIKA Ø70, CZARNY DĄB	8-10	0,3522	2	DESS. XXX	3050
	95-760238521-4	STORAGE, BLAT STOLIKA Ø70, CZARNY DĄB	4-6	0,3522	2	DESS. 521	2660
	95-760238525-4	STORAGE, BLAT STOLIKA Ø70, CZARNY DĄB	4-6	0,3522	2	DESS. 525	2660
	95-760238528-4	STORAGE, BLAT STOLIKA Ø70, CZARNY DĄB	4-6	0,3522	2	DESS. 528	2660
	95-760238565-4	STORAGE, BLAT STOLIKA Ø70, CZARNY DĄB	4-6	0,3522	2	DESS. 565	2660

STORAGE STOLIK, Ø70 CM, DĄB

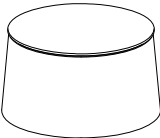
	95-760238XXX-5	STORAGE BLAT STOLIK, Ø70 CM, DĄB NATURALNY	8-10	0,3522	2	DESS. XXX	3050
	95-760238521-5	STORAGE BLAT STOLIK, Ø70 CM, DĄB NATURALNY	4-6	0,3522	2	DESS. 521	2660
	95-760238525-5	STORAGE BLAT STOLIK, Ø70 CM, DĄB NATURALNY	4-6	0,3522	2	DESS. 525	2660
	95-760238528-5	STORAGE BLAT STOLIK, Ø70 CM, DĄB NATURALNY	4-6	0,3522	2	DESS. 528	2660
	95-760238565-5	STORAGE BLAT STOLIK, Ø70 CM, DĄB NATURALNY	4-6	0,3522	2	DESS. 565	2660

EXTRA WYPEŁNIENIE DO BEANBAGS

	420-025	EXTRA WYPEŁNIENIE BEANBAGS, 25 L.	4-6	0,0250	1		120
---	---------	-----------------------------------	-----	--------	---	--	-----

FABRICS

TEKSTYLIA

	01XXX	TKANINA, 1 METR BIEŻĄCY	4-6	0,0020	1	DESS. XXX	190
--	-------	-------------------------	-----	--------	---	-----------	-----

2022 FABRIC FACTS

VIVUS

Dess. 571, 573, 574, 575
 100% Recycled Polyester
 400 g/m²
 78000 Martindale
¹)Fastness to light: 4-5
²)Fastness to rubbing: 4-5
 Oeko-Tex®certified

NIST

Dess. 515
 96% Polyester / 4% Linen
 390 g/m²
 141500 Martindale
¹)Fastness to light: 4-5
²)Fastness to rubbing: 5

SOFT

Dess. 552, 554, 558
 100% Polyester
 460 g/m²
 100000 Martindale
¹)Fastness to light: 4-5
²)Fastness to rubbing: 5
 Oeko-Tex®certified

FLASHTEX

Dess. 216, 217
 100% Polyester
 295 g/m²
 116000 Martindale
¹)Fastness to light: 4-5
²)Fastness to rubbing: 4
 Waterrepellent treatment
 Oeko-Tex®certified

ELEGANCE

Dess. 507, 518
 100% Polyester
 380 g/m²
 60000 Martindale
¹)Fastness to light: 4-5
²)Fastness to rubbing: 4-5
 Waterrepellent treatment
 Oeko-Tex®certified

FAUNAL^{LEATHER LOOK}

Dess. 550, 551
 80% Polyester /
 17.5% Leather /
 2.5% Polyurethane
 335 g/m²
 56000 Martindale
¹)Fastness to light: 4-5
²)Fastness to rubbing: 4

CORDUFINE

Dess. 316, 317, 318
 85% Polyester/15% Nylon
 400 g/m²
 100000 Martindale
¹)Fastness to light: 5
²)Fastness to rubbing: 5
 Waterrepellent treatment
 Oeko-Tex®certified

BOUCLÈ

Dess. 531, 533, 534
 100% Polyester
 430 g/m²
 27000 Martindale
¹)Fastness to light: 4-5
²)Fastness to rubbing: 4-5
 Oeko-Tex®certified

VINTAGE^{LEATHER LOOK}

Dess. 461
 85% Polyvinyl chloride (PVC) /
 15% Viscose
 530 g/m²
 400000 Martindale
¹)Fastness to light: 4-5
²)Fastness to rubbing: 4

BLIDA

Dess. 612
 80% Polyester / 20% Linen
 500 g/m²
 200000 Martindale
¹)Fastness to light: 4-5
²)Fastness to rubbing: 4-5

TWIST

Dess. 563, 565
 100% Polyester
 400 g/m²
 36000 Martindale
¹)Fastness to light: 4-5
²)Fastness to rubbing: 5

MIXED DANCE

Dess. 521, 525, 527, 528
 100% Polyester
 375 g/m²
 85500 Martindale
¹)Fastness to light: 4-5
²)Fastness to rubbing: 5

KENYA

Dess. 577, 578, 579
 100% Polyester
 550 g/m²
 119000 Martindale
¹)Fastness to light: 5
²)Fastness to rubbing: 4-5

ARGUS

Dess. 580, 581, 583, 584, 585
 100% Recycled Polyester
 515 g/m²
 67000 Martindale
¹)Fastness to light: 4-5
²)Fastness to rubbing: 4

PHOBOS

Dess. 586, 587
 100% Polyester
 530 g/m²
 100000 Martindale
¹)Fastness to light: 4-5
²)Fastness to rubbing: 4-5

CORDUROY

Dess. 595
 90% Polyester / 10% Nylon
 370 g/m²
 109000 Martindale
¹)Fastness to light: 5
²)Fastness to rubbing: 4
 Oeko-Tex®certified

MICRO CHECK

Dess. 590
 100% Polyester
 320 g/m²
 27000 Martindale
¹)Fastness to light: 4-5
²)Fastness to rubbing: 4-5
 Oeko-Tex®certified